

*konusulan
the spoken kalite...
quality...*

KANAL AÇMA

KANAL AÇMA TAKIMLARI
GROOVING TOOLHOLDERS





AKKO **A** **AKT** - **K** - **R** - **2525**

1 2 3 4 5

100 - 150 - **4** - **T22**

6 7 8

2 Kesiş Stili / Cutter Style

DKT : Dış Çap Kanal Açma Takımı - External Grooving Toolholders
IKT : Delik İçi Kanal Açma Takımı - Internal Grooving Toolholders
AKT : Dış Çap Alın Kanal Açma Takımı - Face Grooving Toolholders
LKT : L Tip Alın Kanal Açma Takımları - L Type Face Grooving Toolholders

3 Uç Tipi / Insert Type

KRLY / MGM.
HRN / S312, S229, S224, S223
ISCR / DGN, GI, GTN
SNDVK / 123, 151, 154.91
ZCC
KM / A4.
ARN / LOMR.

TGTC / TD.

4 Kesme Yönü / Cutting Direction

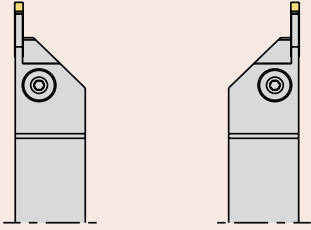

R

L

5 Kesme Kenar Yüksekliği ve Şaft Geniřlięi Cutting Edge Height and Shank Width

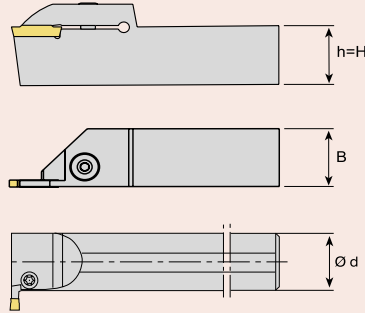

6 Kesme Aralıęı / Cutting Diameter

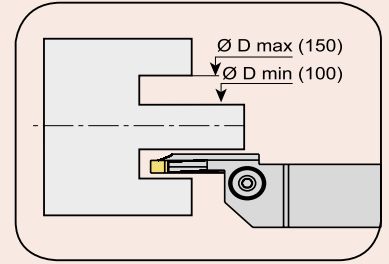

7 Kesme Kenar Geniřlięi / Cutting Width Edge

ÖR/E.G :
2 = 2.0 mm
3 = 3.0 mm
4 = 4.0 mm
5 = 5.0 mm
6 = 6.0 mm
8 = 8.0 mm

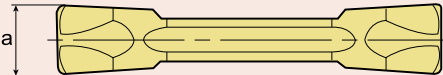

8 Kesme Derinlięi / Cutting Depth

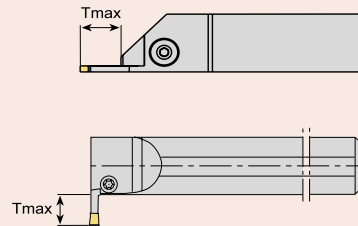

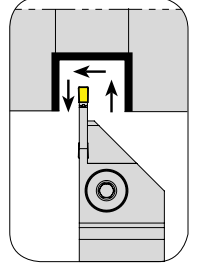
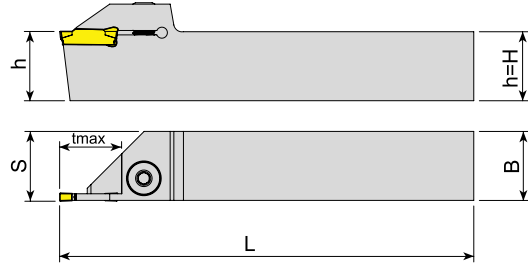

Takım Kodu Ordering Code	Stok Stock		Takım Ölçüleri (mm) Dimension (mm)					Kesici Uç Insert	Yedek Parçaları Spare Parts		
	R	L	h=H	B	L	S	t _{max}		Sıkma Vidası Clamp Screw	Pul Stamp	Anahtar Allen Key
ADKT-K-R/L-1212-2-T15	●	●	12	12	100	16.3	15	MGM. - 2	AKV-02-M6x22	ABPL-01	AAL-03-3
ADKT-K-R/L-1616-2-T15	●	●	16	16	125	16.3	15				
ADKT-K-R/L-2020-2-T15	●	●	20	20	125	20.3	15				
ADKT-K-R/L-2525-2-T15	●	●	25	25	150	25.3	15				
ADKT-K-R/L-3232-2-T15	●	●	32	32	170	32.3	15				
ADKT-K-R/L-1212-3-T15	●	●	12	12	100	16.3	15	MGM. - 3			
ADKT-K-R/L-1616-3-T15	●	●	16	16	125	16.4	15				
ADKT-K-R/L-2020-3-T20	●	●	20	20	125	20.4	20				
ADKT-K-R/L-2020-3-R28	●	○	20	20	125	20.3	28				
ADKT-K-R/L-2525-3-R15	●	○	25	25	150	25.4	15				
ADKT-K-R/L-2525-3-T22	●	●	25	25	150	25.4	22				
ADKT-K-R/L-3232-3-T22	●	●	32	32	170	32.4	22	MGM. - 4	2004-M8x1x20	-	AAL-05-4
ADKT-K-R/L-2020-4-T20	●	●	20	20	125	20.4	20				
ADKT-K-R/L-2020-4-R25	●	○	20	20	125	20.4	25				
ADKT-K-R/L-2525-4-T18	●	●	25	25	150	25.4	18				
ADKT-K-R/L-2525-4-T22	●	●	25	25	150	25.4	22				
ADKT-K-R/L-3232-4-T22	●	●	32	32	170	32.4	22	MGM. - 5			
ADKT-K-R/L-2020-5-T20	●	●	20	20	125	20.5	20				
ADKT-K-R/L-2525-5-T18	●	●	25	25	150	25.5	18				
ADKT-K-R/L-2525-5-T25	●	●	25	25	150	25.5	25	MGM. - 6			
ADKT-K-R/L-3232-5-T25	●	●	32	32	170	32.5	25				
ADKT-K-R/L-2525-6-T25	●	●	25	25	150	25.6	25	MGM. - 8			
ADKT-K-R/L-3232-6-T25	●	●	32	32	170	32.6	25				
ADKT-K-R/L-3232-8-T32	●	●	32	32	170	32.8	32				

R: Sağ/Right L: Sol/Left ● Stokta/In Stock ○ Stokta Yok/Non Stock Item
KRLY - JD Ucuna Uygundur. / Compatiple with KRLY - JD Insert.

Sipariş Örneği/Ordering Example : 1 ad./pcs. ADKT-K-R-1212-2-T15

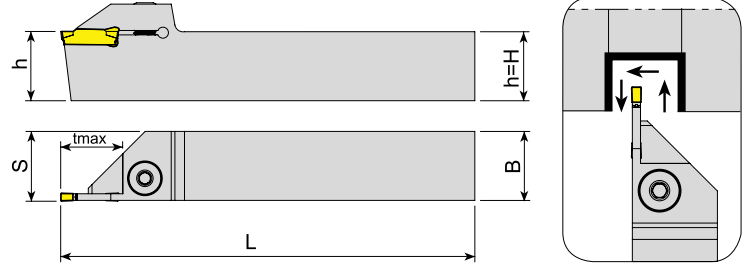

Takım Kodu Ordering Code	Stok Stock		Takım Ölçüleri (mm) Dimension (mm)					Kesici Uç Insert	Yedek Parçaları Spare Parts		
	R	L	h=H	B	L	S	t max		Sıkma Vidası Clamp Screw	Pul Stamp	Anahtar Allen Key
ADKT-KG-R/L-2020-2-T15	●	○	20	20	125	20.2	15	KG.. - 2	AKV-02-M6x22	ABPL-01	AAL-03-3
ADKT-KG-R/L-2525-2-T15	●	○	25	25	150	25.2	15				
ADKT-KG-R/L-2525-2-T17	●	○	25	25	150	25.2	17	KG.. - 3	2004-M8x1x20	-	AAL-05-4
ADKT-KG-R/L-1616-3-T20	●	●	16	16	125	16.3	20				
ADKT-KG-R/L-2020-3-T20	●	●	20	20	125	20.3	20				
ADKT-KG-R/L-2525-3-T22	●	●	25	25	150	25.3	22				
ADKT-KG-R/L-2020-4-T20	●	○	20	20	125	20.4	20				
ADKT-KG-R/L-2525-4-T22	●	○	25	25	150	25.4	22				
ADKT-KG-R/L-2525-5-T25	○	○	25	25	150	25.5	25	KG.. - 5	2004-M8x1x20	-	AAL-05-4
ADKT-KG-R/L-2525-6-T25	○	○	25	25	150	25.6	25	KG.. - 6			

KRLY Ucuna Uygundur. / Compatible with KRLY Insert.

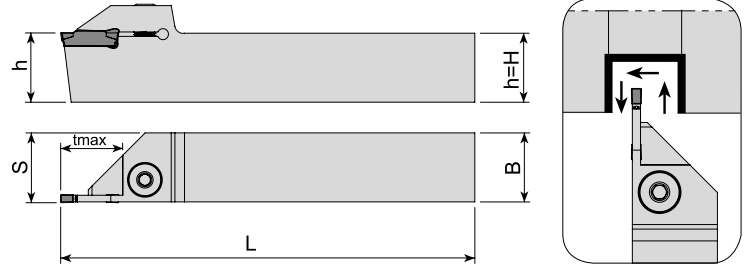

Takım Kodu Ordering Code	Stok Stock		Takım Ölçüleri (mm) Dimension (mm)					Kesici Uç Insert	Yedek Parçaları Spare Parts		
	R	L	h=H	B	L	S	t max		Sıkma Vidası Clamp Screw	Pul Stamp	Anahtar Allen Key
ADKT-SGC-R/L-1212-2-R15	●	●	12	12	100	16.2	15	GCM N20	AKV-02-M6x22	ABPL-01	AAL-03-3
ADKT-SGC-R/L-1616-2-R15	●	●	16	16	125	16.2	15				
ADKT-SGC-R/L-2020-2-R20	●	●	20	20	125	20.2	20				
ADKT-SGC-R/L-2525-2-R20	●	●	25	25	150	25.2	20	GCM N30	2004-M8x1x20	-	AAL-05-4
ADKT-SGC-R/L-1212-3-R15	●	●	12	12	100	16.3	15				
ADKT-SGC-R/L-1616-3-R15	●	●	16	16	125	16.3	15				
ADKT-SGC-R/L-2020-3-R22	●	○	20	20	125	20.3	22				
ADKT-SGC-R/L-2525-3-R15	●	○	25	25	150	25.3	15				
ADKT-SGC-R/L-2525-3-R22	●	●	25	25	150	25.3	22				
ADKT-SGC-R/L-2525-4-R25	●	○	25	25	150	25.4	25	GCM N40	2004-M8x1x20	-	AAL-05-4

R: Sağ/Right L: Sol/Left ● Stokta/In Stock ○ Stokta Yok/Non Stock Item

SMTM Ucuna Uygundur. / Compatible with SMTM Insert.

Sipariş Örneği/Ordering Example : 1 ad./pcs. ADKT-KG-R-2020-2-T15

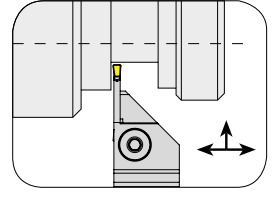
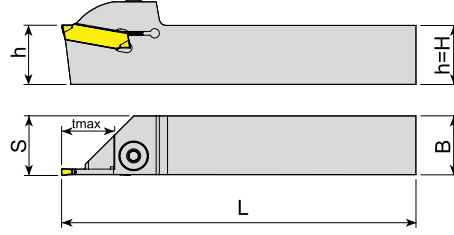

Takım Kodu Ordering Code	Stok Stock		Takım Ölçüleri (mm) Dimension (mm)					Kesici Uç Insert	Yedek Parçaları Spare Parts		
	R	L	h=H	B	L	S	t max		Sıkma Vidası Clamp Screw	Pul Stamp	Anahtar Allen Key
ADKT-H-R/L-2020-3-T20	●	●	20	20	125	20.5	20	S229 - 3	2004-M8x1x20	-	AAL-05-4
ADKT-H-R/L-2525-3-T22	●	●	25	25	150	25.5	22				
ADKT-H-R/L-2020-4-T20	●	●	20	20	125	20.5	20				
ADKT-H-R/L-2525-4-T22	●	●	25	25	150	25.5	22				
ADKT-H-R/L-3232-4-T22	●	●	32	32	170	32.5	22	S229 - 4			
ADKT-H-R/L-2020-5-T20	●	●	20	20	125	20.5	20	S229 - 5			
ADKT-H-R/L-2525-5-T25	●	●	25	25	150	25.5	25	S229 - 6			
ADKT-H-R/L-2525-6-T25	●	●	25	25	150	25.6	25				

HRN Ucuna Uygundur. / Compatible with HRN Insert.

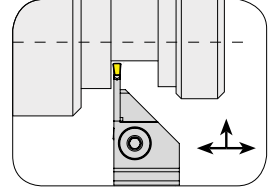
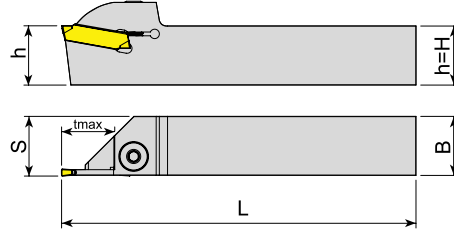

Takım Kodu Ordering Code	Stok Stock		Takım Ölçüleri (mm) Dimension (mm)					Kesici Uç Insert	Yedek Parçaları Spare Parts		
	R	L	h=H	B	L	S	t max		Sıkma Vidası Clamp Screw	Pul Stamp	Anahtar Allen Key
ADKT-HK-R/L-1616-2-T15	●	●	16	16	125	16.3	15	S224 - 2	AKV-02-M6x22	ABPL-01	AAL-03-3
ADKT-HK-R/L-2020-2-T15	●	●	20	20	125	20.3	15				
ADKT-HK-R/L-2525-2-T15	●	●	25	25	150	25.3	15	S224 - 3	2004-M8x1x20	-	AAL-05-4
ADKT-HK-R/L-1616-3-T15	○	○	16	16	125	16.3	15				
ADKT-HK-R/L-2020-3-T20	●	●	20	20	125	20.4	20				
ADKT-HK-R/L-2525-3-T22	●	●	25	25	150	25.4	22				
ADKT-HK-R/L-2020-4-T20	●	●	20	20	125	20.4	20	S224 - 4			
ADKT-HK-R/L-2525-4-T22	●	●	25	25	150	25.4	22	S223 - 2	AKV-02-M6x22	ABPL-01	AAL-03-3
ADKT-HS223-R/L-2020-2-T15	●	○	20	20	125	20.4	15				

R: Sağ/Right L: Sol/Left ● Stokta/In Stock ○ Stokta Yok/Non Stock Item
HRN Ucuna Uygundur. / Compatible with HRN Insert.

Sipariş Örneği/Ordering Example : 1 ad./pcs. ADKT-H-R-2020-3-T20

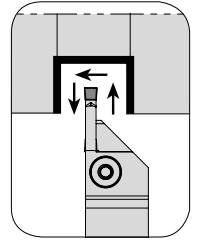
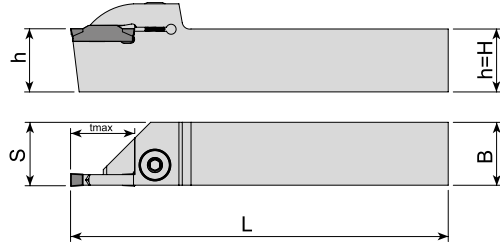

Takım Kodu Ordering Code	Stok Stock		Takım Ölçüleri (mm) Dimension (mm)					Kesici Uç Insert	Yedek Parçaları Spare Parts		
	R	L	h=H	B	L	S	t max		Sıkma Vidası Clamp Screw	Pul Stamp	Anahtar Allen Key
ADKT-ZCC2-R/L-1616-2-T15	●	●	16	16	125	16.3	15	Z.BD - 2	AKV-02-M6x22	ABPL-01	AAL-03-3
ADKT-ZCC2-R/L-2020-2-T15	●	●	20	20	125	20.3	15				
ADKT-ZCC2-R/L-2525-2-T15	●	●	25	25	150	25.3	15				
ADKT-ZCC2-R/L-2525-2.5-T15	●	●	25	25	150	25.3	15	Z.ED - 2.5			
ADKT-ZCC2-R/L-1616-3-T15	●	○	16	16	125	16.3	15	Z.FD - 3	2004-M8x1x20	-	AAL-05-4
ADKT-ZCC2-R/L-2020-3-T12	●	○	20	20	125	20.3	12				
ADKT-ZCC2-R/L-2020-3-T20	●	●	20	20	125	20.3	20				
ADKT-ZCC2-R/L-2525-3-T12	●	○	25	25	150	25.3	12				
ADKT-ZCC2-R/L-2525-3-T22	●	●	25	25	150	25.3	22				
ADKT-ZCC2-R/L-2525-3-R30	●	●	25	25	150	25.3	30				
ADKT-ZCC2-R/L-2020-4-T12	●	○	20	20	125	20.5	12	Z.GD - 4	2004-M8x1x20	-	AAL-05-4
ADKT-ZCC2-R/L-2020-4-T20	●	●	20	20	125	20.5	20				
ADKT-ZCC2-R/L-2525-4-T12	●	○	25	25	150	25.5	12				
ADKT-ZCC2-R/L-2525-4-T22	●	●	25	25	150	25.5	22				
ADKT-ZCC2-R/L-2020-5-T12	●	○	20	20	125	20.5	12	Z.HD - 5	2004-M8x1x20	-	AAL-05-4
ADKT-ZCC2-R/L-2020-5-T20	●	●	20	20	125	20.5	20				
ADKT-ZCC2-R/L-2525-5-T12	●	○	25	25	150	25.5	12				
ADKT-ZCC2-R/L-2525-5-T25	●	●	25	25	150	25.5	25				
ADKT-ZCC2-R/L-2020-6-T20	●	●	20	20	125	20.6	20	Z.KD - 6	2004-M8x1x20	-	AAL-05-4
ADKT-ZCC2-R/L-2525-6-T25	●	●	25	25	150	25.6	25				
ADKT-ZCC2-R/L-3232-6-T25	●	●	32	32	170	32.6	25				
ADKT-ZCC2-R/L-3232-6-T30	●	●	32	32	170	32.6	30				

R: Sağ/Right L: Sol/Left ● Stokta/In Stock ○ Stokta Yok/Non Stock Item
ZCC Ucuna Uygunudur. / Compatible with ZCC Insert.

Sipariş Örneği/Ordering Example : 1 ad./pcs. ADKT-ZCC2-R-1616-2-T15



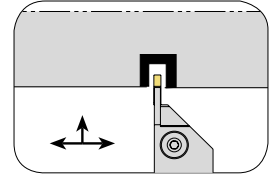
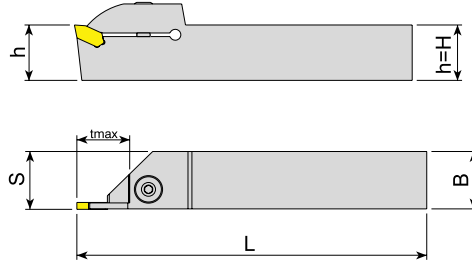

Takım Kodu Ordering Code	Stok Stock		Takım Ölçüleri (mm) Dimension (mm)					Kesici Uç Insert	Yedek Parçaları Spare Parts		
	R	L	h=H	B	L	S	t _{max}		Sıkma Vidası Clamp Screw	Pul Stamp	Anahtar Allen Key
ADKT-ZCC1-R/L-2020-3-T20	●	○	20	20	125	20.3	20	ZQMX - 3	2004-M8x1x20	-	AAL-05-4
ADKT-ZCC1-R/L-2525-3-T22	●	○	25	25	150	25.3	22				
ADKT-ZCC1-R/L-2020-4-T20	●	○	20	20	125	20.4	20	ZQMX - 4	2004-M8x1x20	-	AAL-05-4
ADKT-ZCC1-R/L-2525-4-T22	●	○	25	25	150	25.4	22				

ZCC Ucuna Uygun. / Compatible with ZCC Insert.

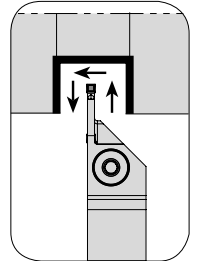
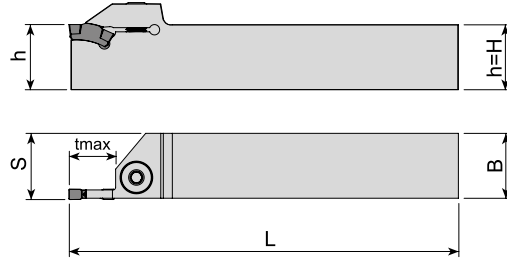

Takım Kodu Ordering Code	Stok Stock		Takım Ölçüleri (mm) Dimension (mm)					Kesici Uç Insert	Yedek Parçaları Spare Parts		
	R	L	h=H	B	L	S	t _{max}		Sıkma Vidası Clamp Screw	Pul Stamp	Anahtar Allen Key
ADKT-ITG-R/L-2020-3-T8	●	●	20	20	125	20.3	8	TGM. - 3	2004-M8x1x20	-	AAL-05-4
ADKT-ITG-R/L-2525-3-T8	●	●	25	25	150	25.3	8				
ADKT-ITG-R/L-3232-3-T8	●	○	32	32	170	32.3	8	TGM. - 4	2004-M8x1x20	-	AAL-05-4
ADKT-ITG-R/L-2020-4-T9	●	●	20	20	125	20.4	9				
ADKT-ITG-R/L-2525-4-T17	●	●	25	25	150	25.4	17	TGM. - 5	2004-M8x1x20	-	AAL-05-4
ADKT-ITG-R/L-3232-4-T17	●	●	32	32	170	32.4	17				
ADKT-ITG-R/L-3232-5-T25	●	○	32	32	170	32.5	25				

R: Sağ/Right L: Sol/Left ● Stokta/In Stock ○ Stokta Yok/Non Stock Item
ISCR Ucuna Uygun. / Compatible with ISCR Insert.

Sipariş Örneği/Ordering Example : 1 ad./pcs. ADKT-ZCC1-R-2020-3-T20

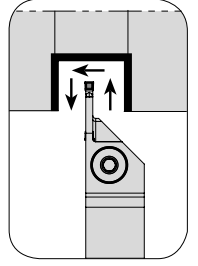
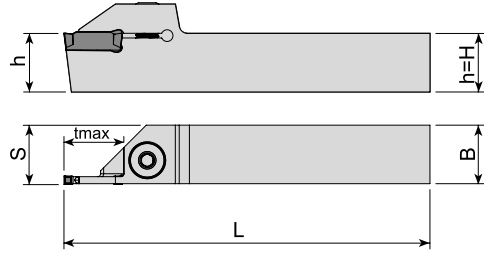

Takım Kodu Ordering Code	Stok Stock		Takım Ölçüleri (mm) Dimension (mm)					Kesici Uç Insert	Yedek Parçaları Spare Parts		
	R	L	h=H	B	L	S	t max		Sıkma Vidası Clamp Screw	Pul Stamp	Anahtar Allen Key
ADKT-I-R/L-1212-2-T15	●	●	12	12	125	16.3	15	DGN - 2	AKV-02-M6x22	ABPL-01	AAL-03-3
ADKT-I-R/L-1616-2-T15	●	●	16	16	100	16.3	15				
ADKT-I-R/L-2020-2-T15	●	●	20	20	125	20.3	15				
ADKT-I-R/L-2525-2-T15	●	●	25	25	150	25.3	15				
ADKT-I-R/L-3232-2-T15	●	●	32	32	170	32.3	15				
ADKT-I-R/L-1212-3-T15	●	●	12	12	100	16.3	15	DGN - 3			
ADKT-I-R/L-1616-3-T15	●	●	16	16	125	16.4	15				
ADKT-I-R/L-2020-3-T20	●	●	20	20	125	20.4	20				
ADKT-I-R/L-2525-3-T22	●	●	25	25	150	25.4	22				
ADKT-I-R/L-3232-3-T22	●	●	32	32	170	32.4	22				
ADKT-I-R/L-2020-4-T20	●	●	20	20	125	20.4	20	DGN / GRP - 4	2004-M8x1x20	-	AAL-05-4
ADKT-I-R/L-2525-4-T22	●	●	25	25	150	25.4	22				
ADKT-I-R/L-3232-4-T25	●	●	32	32	170	32.4	25	DGN / GRP - 5			
ADKT-I-R/L-2020-5-T20	●	●	20	20	125	20.5	20				
ADKT-I-R/L-2525-5-T25	●	●	25	25	150	25.5	25	GRP - 3			
ADKT-IG-R/L-2020-3-R20	●	●	20	20	125	20.4	20				
ADKT-IG-R/L-2525-3-T22	●	●	25	25	150	25.4	22	GIM / GIP - 2	AKV-02-M6x22	ABPL-01	AAL-03-3
ADKT-IGI-R/L-2020-2-T15	●	○	20	20	125	20.3	15				
ADKT-IGI-R/L-2525-2-T15	●	○	25	25	150	25.4	15	GIM / GIP - 3			
ADKT-IGI-R/L-1616-3-T15	●	●	16	16	125	16.4	15				
ADKT-IGI-R/L-2020-3-T20	●	●	20	20	125	20.4	20	GIM / GIP - 4	2004-M8x1x20	-	AAL-05-4
ADKT-IGI-R/L-2525-3-T22	●	●	25	25	150	25.4	22				
ADKT-IGI-R/L-2525-4-T22	●	●	25	25	150	25.5	22	GIM / GIP - 5			
ADKT-IGI-R/L-2525-5-T25	●	●	25	25	150	25.6	25				
ADKT-IGI-R/L-2525-8-T30	●	○	25	25	150	25.8	30	GIM / GIP - 8			
ADKT-IGTN-R/L-2525-5-T25	●	●	25	25	150	25.6	25				
ADKT-IDC-R/L-2525-3-T21	●	○	25	25	150	25.4	21	DCE - 3			

R: Sağ/Right L: Sol/Left ● Stokta/In Stock ○ Stokta Yok/Non Stock Item
ISCR Ucuna Uygun. / Compatible With ISCR Insert

Sipariş Örneği/Ordering Example : 1 ad./pcs. ADKT-I-R-1212-2-T15

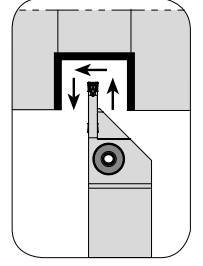
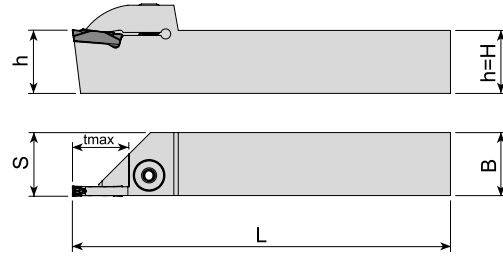

Takım Kodu Ordering Code	Stok Stock		Takım Ölçüleri (mm) Dimension (mm)					Kesici Uç Insert	Yedek Parçaları Spare Parts		
	R	L	h=H	B	L	S	t _{max}		Sıkma Vidası Clamp Screw	Pul Stamp	Anahtar Allen Key
ADKT-KM-R/L-2020-2-T15	●	●	20	20	125	20.3	15	A4. - 2	AKV-02-M6x22	ABPL-01	AAL-03-3
ADKT-KM-R/L-2525-2-T15	●	●	25	25	150	25.3	15				
ADKT-KM-R/L-2020-3-T20	●	●	20	20	125	20.4	20	A4. - 3	2004-M8x1x20	-	AAL-05-4
ADKT-KM-R/L-2525-3-T22	●	●	25	25	150	25.4	22				
ADKT-KM-R/L-2525-4-T22	●	●	25	25	150	25.5	22	A4. - 4			

KNMNTL Ucuna Uygunur. / Compatible with KNMNTL Insert.

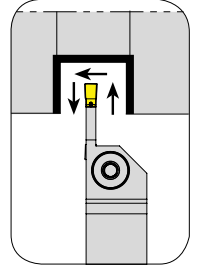
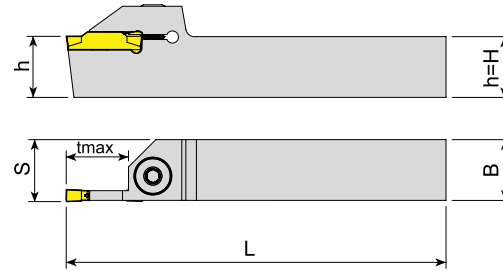

Takım Kodu Ordering Code	Stok Stock		Takım Ölçüleri (mm) Dimension (mm)					Kesici Uç Insert	Yedek Parçaları Spare Parts		
	R	L	h=H	B	L	S	t _{max}		Sıkma Vidası Clamp Screw	Pul Stamp	Anahtar Allen Key
ADKT-123-R/L-1212-1.5-R15	●	●	12	12	100	16.2	15	123 - 1.5	AKV-02-M6x22	ABPL-01	AAL-03-3
ADKT-123-R/L-1616-1.5-R15	●	●	16	16	125	16.3	15				
ADKT-123-R/L-1616-2-T15	●	○	16	16	125	16.3	15	123 - 2	AKV-02-M6x22	ABPL-01	AAL-03-3
ADKT-123-R/L-2020-2-T8	●	○	20	20	125	20.2	8				
ADKT-123-R/L-2020-2-T15	●	●	20	20	125	20.3	15	123 - 3	2004-M8x1x20	-	AAL-05-4
ADKT-123-R/L-2525-2-T15	●	●	25	25	150	25.3	15				
ADKT-123-R/L-3232-2-T15	●	●	32	32	170	32.3	15	123 - 4	2004-M8x1x20	-	AAL-05-4
ADKT-123-R/L-1616-3-T15	●	●	16	16	125	16.4	15				
ADKT-123-R/L-2020-3-T20	●	●	20	20	125	20.4	20	123 - 5	2004-M8x1x20	-	AAL-05-4
ADKT-123-R/L-2525-3-T22	●	●	25	25	150	25.4	22				
ADKT-123-R/L-2020-4-T20	●	●	20	20	125	20.4	20	123 - 6	2004-M8x1x20	-	AAL-05-4
ADKT-123-R/L-2525-4-T22	●	●	25	25	150	25.4	22				
ADKT-123-R/L-3232-4-T25	●	●	32	32	170	32.4	25	123 - 5	2004-M8x1x20	-	AAL-05-4
ADKT-123-R/L-2020-5-T20	●	●	20	20	125	20.5	20				
ADKT-123-R/L-2525-5-T25	●	●	25	25	150	25.5	25	123 - 6	2004-M8x1x20	-	AAL-05-4
ADKT-123-R/L-3232-6-T15	●	○	32	32	170	32.5	15				

R: Sağ/Right L: Sol/Left ● Stokta/In Stock ○ Stokta Yok/Non Stock Item
SNDVK Ucuna Uygunur. / Compatible with SNDVK Insert.

Sipariş Örneği/Ordering Example : 1 ad./pcs. ADKT-KM-R-2020-2-T15

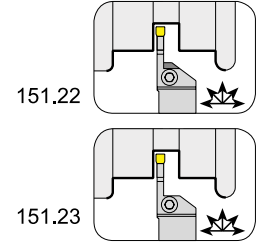
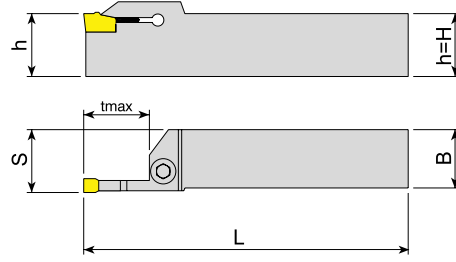

Takım Kodu Ordering Code	Stok Stock		Takım Ölçüleri (mm) Dimension (mm)					Kesici Uç Insert	Yedek Parçaları Spare Parts		
	R	L	h=H	B	L	S	t max		Sıkma Vidası Clamp Screw	Pul Stamp	Anahtar Allen Key
ADKT-151.22-R/L-1616-2-T15	●	●	16	16	125	16.3	15	151.2 - 2	AKV-02-M6x22	ABPL-01	AAL-03-3
ADKT-151.22-R/L-2020-2-T15	●	●	20	20	125	20.3	15				
ADKT-151.22-R/L-2525-2-T15	●	●	25	25	150	25.3	15				
ADKT-151.22-R/L-1616-3-T15	●	●	16	16	125	16.4	15	151.2 - 3	2004-M8x1x20	-	AAL-05-4
ADKT-151.22-R/L-2020-3-T20	●	●	20	20	125	20.4	20				
ADKT-151.22-R/L-2525-3-T22	●	●	25	25	150	25.4	22				
ADKT-151.22-R/L-1616-4-T15	●	●	16	16	125	16.4	15	151.2 - 4	2004-M8x1x20	-	AAL-05-4
ADKT-151.22-R/L-2020-4-T20	●	●	20	20	125	20.4	20				
ADKT-151.22-R/L-2525-4-T22	●	●	25	25	150	25.4	22				
ADKT-151.22-R/L-2020-5-T20	●	●	20	20	125	20.5	20	151.2 - 5	2004-M8x1x20	-	AAL-05-4
ADKT-151.22-R/L-2525-5-T25	●	●	25	25	150	25.5	25				
ADKT-151.23-R/L-1616-2-T15	●	●	16	16	125	16.3	15	151.2 - 2	AKV-02-M6x22	ABPL-01	AAL-03-3
ADKT-151.23-R/L-2020-2-T15	●	●	20	20	125	20.3	15				
ADKT-151.23-R/L-2525-2-T15	●	●	25	25	150	25.3	15				
ADKT-151.23-R/L-1616-2.5-T15	●	●	16	16	125	16.3	15	151.2 - 2.5	2004-M8x1x20	-	AAL-05-4
ADKT-151.23-R/L-2020-2.5-T15	●	●	20	20	125	20.3	15				
ADKT-151.23-R/L-2525-2.5-T15	●	●	25	25	150	25.3	15				
ADKT-151.23-R/L-1212-3-T15	●	●	12	12	100	16.4	15	151.2 - 3	2004-M8x1x20	-	AAL-05-4
ADKT-151.23-R/L-1616-3-T15	●	●	16	16	125	16.4	15				
ADKT-151.23-R/L-2020-3-T20	●	●	20	20	125	20.4	20				
ADKT-151.23-R/L-2525-3-T20	●	●	25	25	150	25.4	20	151.2 - 4	2004-M8x1x20	-	AAL-05-4
ADKT-151.23-R/L-2525-3-T22	●	●	25	25	150	25.4	22				
ADKT-151.23-R/L-1616-4-T15	●	●	16	16	125	16.4	15				
ADKT-151.23-R/L-2020-4-T20	●	●	20	20	125	20.4	20	151.2 - 5	2004-M8x1x20	-	AAL-05-4
ADKT-151.23-R/L-2525-4-T22	●	●	25	25	150	25.4	22				
ADKT-151.23-R/L-2020-5-T20	●	●	20	20	125	20.5	20	151.2 - 5	2004-M8x1x20	-	AAL-05-4
ADKT-151.23-R/L-2525-5-T25	●	●	25	25	150	25.5	25				

R: Sağ/Right L: Sol/Left ● Stokta/In Stock ○ Stokta Yok/Non Stock Item
SNDVK Ucuna Uygundur. / Compatible with SNDVK Insert.

Sipariş Örneği/Ordering Example : 1 ad./pcs. ADKT-151.22-R-1616-2-T15

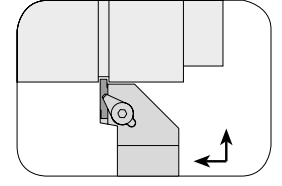
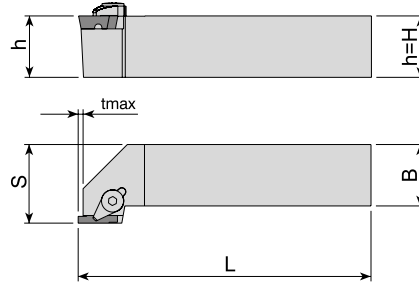

Takım Kodu Ordering Code	Stok Stock	Takım Ölçüleri (mm) Dimension (mm)						Kesici Uç Insert	Yedek Parçaları Spare Parts			
		R	L	h=H	B	L	S		t max	Baskı Parçası Wedge Clamp	Sıkma Vidası Clamp Screw	Pim Pin
ADKT-154.91-R/L-2020-3-T4	●	●	20	20	125	25	4	154.91 - 3	ACK-03	AKV-07-M6x22	APM-06	AAL-03-3
ADKT-154.91-R/L-2525-3-T4	●	●	25	25	150	30.5	4					
ADKT-154.91-R/L-2020-5-T5	●	●	20	20	125	25	5	154.91 - 5	ACK-03	AKV-07-M6x22	APM-06	AAL-03-3
ADKT-154.91-R/L-2525-5-T5	●	●	25	25	150	30.5	5					

SNDVK Ucuna Uygundur. / Compatible with SNDVK Insert.

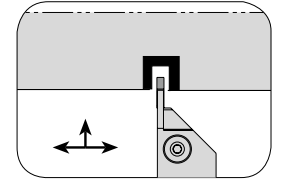
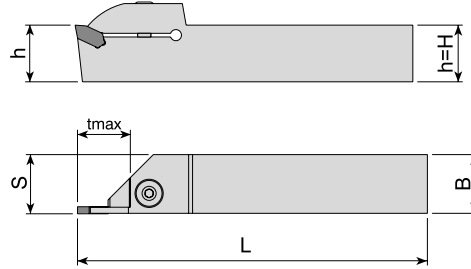

Takım Kodu Ordering Code	Stok Stock	Takım Ölçüleri (mm) Dimension (mm)						Kesici Uç Insert	Yedek Parçaları Spare Parts		
		R	L	h=H	B	L	S		t max	Sıkma Vidası Clamp Screw	Pul Stamp
ADKT-ARN-R/L-2020-2-T15	●	●	20	20	125	20.3	15	LOMR. - 2	AKV-02-M6x22	ABPL-01	AAL-03-3
ADKT-ARN-R/L-2525-2-T15	●	●	25	25	150	25.3	15				
ADKT-ARN-R/L-2020-3-T20	●	●	20	20	125	20.4	20	LOMR. - 3	2004-M8x1x20	-	AAL-05-4
ADKT-ARN-R/L-2525-3-T22	●	●	25	25	150	25.4	22				

R: Sağ/Right L: Sol/Left ● Stokta/In Stock ○ Stokta Yok/Non Stock Item
ARN Ucuna Uygundur. / Compatible with ARN Insert.

Sipariş Örneği/Ordering Example : 1 ad./pcs. ADKT-154.91-R-2020-3-T4

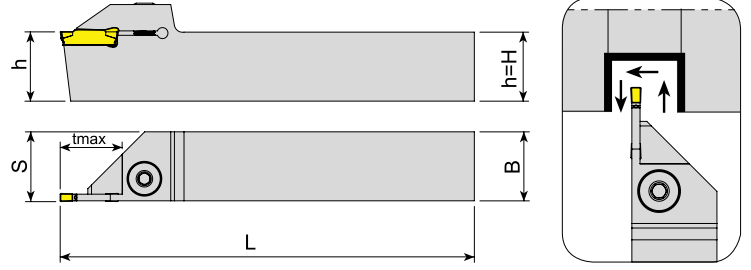

Takım Kodu Ordering Code	Stok Stock		Takım Ölçüleri (mm) Dimension (mm)					Kesici Uç Insert	Yedek Parçaları Spare Parts		
	R	L	h=H	B	L	S	t max		Sıkma Vidası Clamp Screw	Pul Stamp	Anahtar Allen Key
ADKT-TD-R/L-1212-2-T15	●	●	12	12	100	16.3	15	TD. - 2	AKV-02-M6x22	ABPL-01	AAL-03-3
ADKT-TD-R/L-1616-2-T15	●	●	16	16	125	16.3	15				
ADKT-TD-R/L-2020-2-T15	●	●	20	20	125	20.3	15				
ADKT-TD-R/L-2525-2-T17	●	●	25	25	150	25.3	17				
ADKT-TD-R/L-1212-3-T15	●	○	12	12	100	16.3	15	TD. - 3	2004-M8x1x20	-	AAL-05-4
ADKT-TD-R/L-1616-3-T15	●	●	16	16	125	16.4	15				
ADKT-TD-R/L-2020-3-T20	●	●	20	20	125	20.4	20				
ADKT-TD-R/L-2525-3-T9	●	●	25	25	150	25.4	9				
ADKT-TD-R/L-2525-3-T22	●	●	25	25	150	25.4	22	TD. - 4			
ADKT-TD-R/L-2525-4-T22	●	●	25	25	150	25.5	22				
ADKT-TD-R/L-2525-5-T25	○	○	25	25	150	25.5	25	TD. - 5			

TGTC Ucuna Uygun. / Compatible With TGTC Insert.

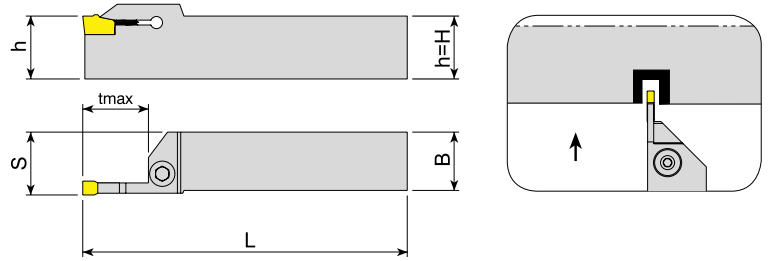

Takım Kodu Ordering Code	Stok Stock		Takım Ölçüleri (mm) Dimension (mm)					Kesici Uç Insert	Yedek Parçaları Spare Parts		
	R	L	h=H	B	L	S	t max		Sıkma Vidası Clamp Screw	Pul Stamp	Anahtar Allen Key
ADKT-SWC-R/L-2020-2-T25	●	○	20	20	125	20.3	25	WCF. - 2	AKV-02-M6x22	ABPL-01	AAL-03-3
ADKT-SWC-R/L-2020-3-T25	●	○	20	20	125	20.4	25	WCF. - 3	2004-M8x1x20	-	AAL-05-4

R: Sağ/Right L: Sol/Left ● Stokta/In Stock ○ Stokta Yok/Non Stock Item
SMTM Ucuna Uygun. / Compatible with SMTM Insert.

Sipariş Örneği/Ordering Example : 1 ad./pcs. ADKT-TD-R-1212-2-T15

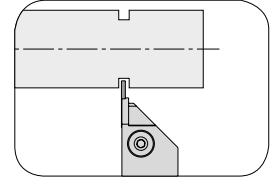
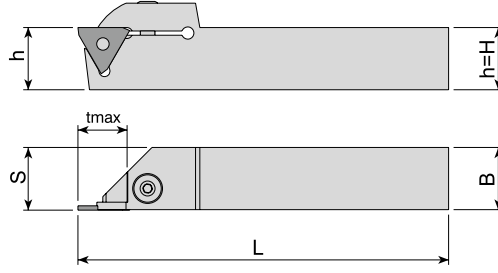

Takım Kodu Ordering Code	Stok Stock		Takım Ölçüleri (mm) Dimension (mm)					Kesici Uç Insert	Yedek Parçaları Spare Parts		
	R	L	h=H	B	L	S	t _{max}		Sıkma Vidası Clamp Screw	Pul Stamp	Anahtar Allen Key
ADKT-H22-R/L-1616-(0.5-2)-T6	●	●	16	16	125	16.2	6				AAL-05-4
ADKT-H22-R/L-2020-(0.5-2)-T6	●	●	20	20	125	20.2	6				
ADKT-H22-R/L-2525-(0.5-2)-T6	●	●	25	25	150	25.2	6				

HRN Ucuna Uygun. / Compatible with HRN Insert.

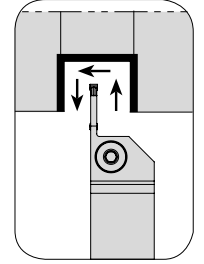
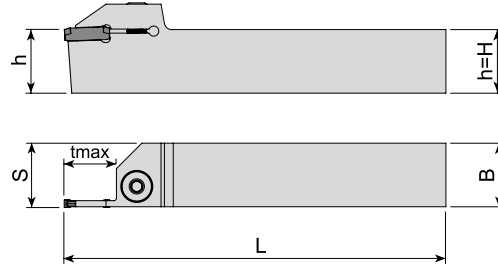

Takım Kodu Ordering Code	Stok Stock		Takım Ölçüleri (mm) Dimension (mm)					Kesici Uç Insert	Yedek Parçaları Spare Parts		
	R	L	h=H	B	L	S	t _{max}		Sıkma Vidası Clamp Screw	Pul Stamp	Anahtar Allen Key
ADKT-LGC-R/L-1616-2-D40	●	●	16	16	125	16.2	20				AAL-03-3
ADKT-LGC-R/L-2020-2-D40	●	●	20	20	125	20.2	20				
ADKT-LGC-R/L-2525-2-D40	●	●	25	25	150	25.2	20				
ADKT-LGC-R/L-1616-3-T20	●	●	16	16	125	16.3	20				AAL-05-4
ADKT-LGC-R/L-2020-3-T20	●	●	20	20	125	20.3	20				
ADKT-LGC-R/L-2525-3-T20	●	●	25	25	150	25.3	20				

R: Sağ/Right L: Sol/Left ● Stokta/In Stock ○ Stokta Yok/Non Stock Item
LMN Ucuna Uygun. / Compatible with LMN Insert.

Sipariş Örneği/Ordering Example : 1 ad./pcs. ADKT-H22-R-1616-(0.5-2)T16

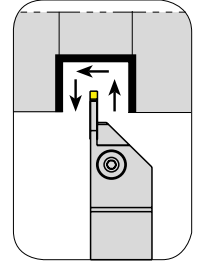
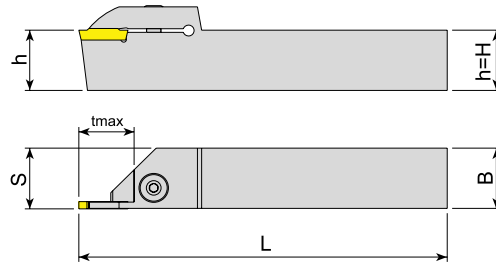

Takım Kodu Ordering Code	Stok Stock		Takım Ölçüleri (mm) Dimension (mm)					Kesici Uç Insert	Yedek Parçaları Spare Parts		
	R	L	h=H	B	L	S	t max		Sıkma Vidası Clamp Screw	Pul Stamp	Anahtar Allen Key
ADKT-WGX24-R/L-2525-3-T22	●	○	25	25	150	25.3	22		2004-M8x1x20		
ADKT-WGX24-R/L-2525-4-T22	●	●	25	25	150	25.4	22	GX24 - 4			
ADKT-WGX24-R/L-2525-5-T25	●	●	25	25	150	25.5	25	GX24 - 5			
ADKT-WGX24-R/L-3232-5-T25	●	○	32	32	170	32.5	25				

WLTR Ucuna Uygundur. / Compatible with WLTR Insert.

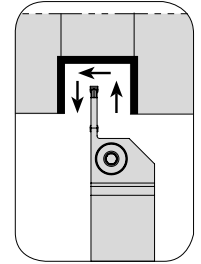
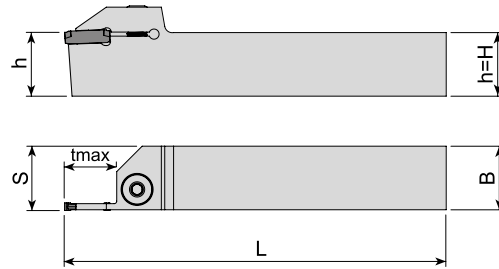

Takım Kodu Ordering Code	Stok Stock		Takım Ölçüleri (mm) Dimension (mm)					Kesici Uç Insert	Yedek Parçaları Spare Parts		
	R	L	h=H	B	L	S	t max		Sıkma Vidası Clamp Screw	Pul Stamp	Anahtar Allen Key
ADKT-GP-R/L-2020-3-T20	●	●	20	20	125	20.3	20		2004-M8x1x20		
ADKT-GP-R/L-2525-3-T22	●	●	25	25	150	25.3	22	GP - 3			
ADKT-GP-R/L-2525-4-T22	●	●	25	25	150	25.4	22	GP - 4			
ADKT-GP-R/L-2525-5-T25	●	●	25	25	150	25.5	25				

R: Sağ/Right L: Sol/Left ● Stokta/In Stock ○ Stokta Yok/Non Stock Item
PLBT Ucuna Uygundur. / Compatible with PLBT Insert.

Sipariş Örneği/Ordering Example : 1 ad./pcs. ADKT-WGX24-R-2525-3-T22

> DIŞ ÇAP KANAL AÇMA TAKIMLARI
EXTERNAL GROOVING TOOLHOLDERS

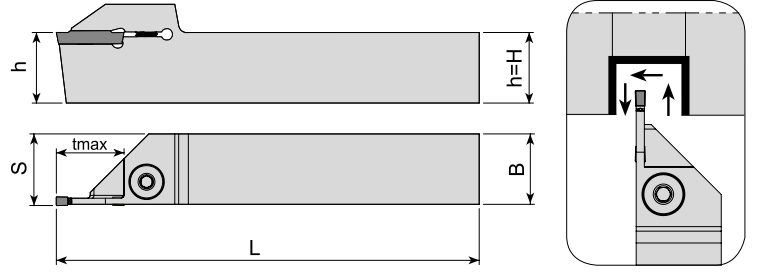

Takım Kodu Ordering Code	Stok Stock		Takım Ölçüleri (mm) Dimension (mm)				Kesici Uç Insert	Yedek Parçaları Spare Parts			
	R	L	h=H	B	L	S		t max	Sıkma Vidası Clamp Screw	Pul Stamp	Anahtar Allen Key
ADKT-CD-R/L-2020-3-R20	●	○	20	20	125	20.3	20	GX24 0300	2004-M8x1x20	-	AAL-05-4
ADKT-CD-R/L-2525-3-R23	●	○	25	25	150	25.3	23				

CRTZT Ucuna Uygunudur. / Compatible with CRTZT Insert.

> DIŞ ÇAP KANAL AÇMA İSVİÇRE TİPİ KAYAR OTOMAT MAKİNA TAKIMLARI
EXTERNAL GROOVING TOOLHOLDERS FOR SWISS TYPE SLIDING AUTOMATIC LATHES

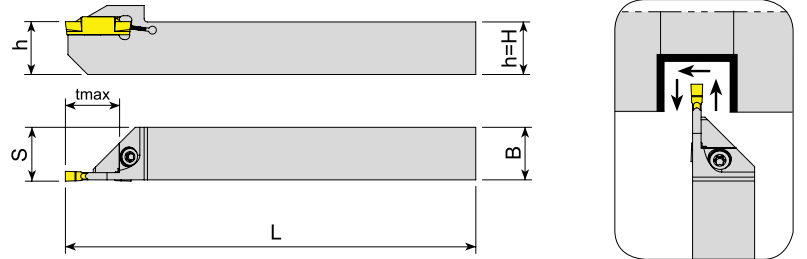

Takım Kodu Ordering Code	Stok Stock		Takım Ölçüleri (mm) Dimension (mm)				Kesici Uç Insert	Yedek Parçaları Spare Parts			
	R	L	h=H	B	L	S		t max	Sıkma Vidası Clamp Screw	Pul Stamp	Tork Anahtar Torx Key
ADKT-TD-R/L-1212-2-T12-K-S	●	●	12	12	125	12.2	12	TD. - 2	1515-M4x11	-	80-T15
ADKT-TD-R/L-1616-2-T16-K-S	●	●	16	16	125	16.2	16				
ADKT-TD-R/L-1212-3-T12-K-S	●	●	12	12	125	12.3	12	TD. - 3	-	-	-
ADKT-TD-R/L-1616-3-T16-K-S	●	●	16	16	125	16.3	16				

R: Sağ/Right L: Sol/Left ● Stokta/In Stock ○ Stokta Yok/Non Stock Item
TGTC Ucuna Uygunudur. / Compatible with TGTC Insert.

Sipariş Örneği/Ordering Example : 1 ad./pcs. ADKT-CD-R-2020-3-R20

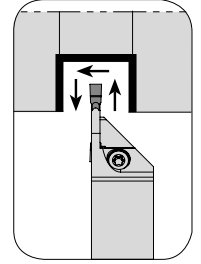
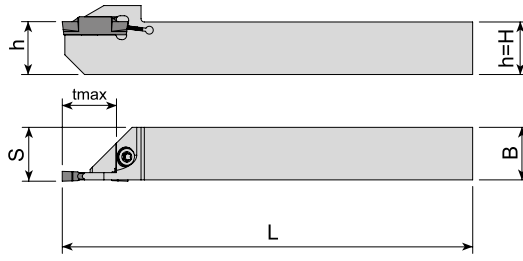

Takım Kodu Ordering Code	Stok Stock		Takım Ölçüleri (mm) Dimension (mm)					Kesici Uç Insert	Yedek Parçaları Spare Parts		
	R	L	h=H	B	L	S	t max		Sıkma Vidası Clamp Screw	Pul Stamp	Tork Anahtar Torx Key
ADKT-ZCC2-R/L-1010-2-T12-K-S	●	●	10	10	125	10.2	12	Z.BD - 2	1515-M4x11	-	80-T15
ADKT-ZCC2-R/L-1212-2-T12-K-S	●	●	12	12	125	12.2	12				
ADKT-ZCC2-R/L-1616-2-R16-K-S	●	●	16	16	125	16.2	16	Z.FD - 3	-	-	-
ADKT-ZCC2-R/L-1212-3-T12-K-S	●	●	12	12	125	12.3	12				

ZCC Ucuna Uygundur. / Compatible with ZCC Insert.

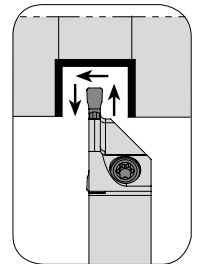
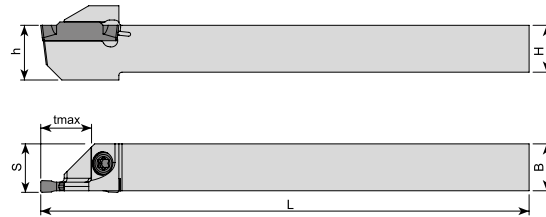

Takım Kodu Ordering Code	Stok Stock		Takım Ölçüleri (mm) Dimension (mm)					Kesici Uç Insert	Yedek Parçaları Spare Parts		
	R	L	h=H	B	L	S	t max		Sıkma Vidası Clamp Screw	Pul Stamp	Tork Anahtar Torx Key
ADKT-KG-R/L-1212-2-R12-K-S	●	●	12	12	125	12.2	12	KG. - 2	1515-M4x11	-	80-T15
ADKT-KG-R/L-1212-3-R12-K-S	●	●	12	12	125	12.4	12	KG. - 3			

R: Sağ/Right L: Sol/Left ● Stokta/In Stock ○ Stokta Yok/Non Stock Item
KRLY Ucuna Uygundur. / Compatible with KRLY Insert.

Sipariş Örneği/Ordering Example : 1 ad./pcs. ADKT-ZCC2-R-1010-2-T12-K-S

➤ DIŞ ÇAP KANAL AÇMA İSVİÇRE TİPİ KAYAR OTOMAT MAKİNA TAKIMLARI
EXTERNAL GROOVING TOOLHOLDERS FOR SWISS TYPE SLIDING AUTOMATIC LATHES

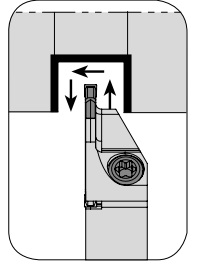
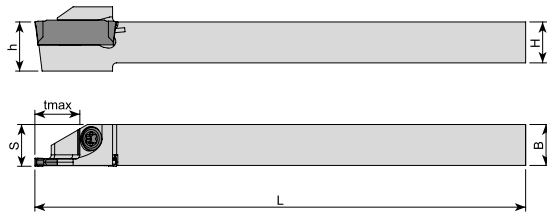

Takım Kodu Ordering Code	Stok Stock		Takım Ölçüleri (mm) Dimension (mm)					Kesici Uç Insert	Yedek Parçaları Spare Parts		
	R	L	h=H	B	L	S	t max		Sıkma Vidası Clamp Screw	Pul Stamp	Tork Anahtar Torx Key
ADKT-I-R/L-0808-2-R10-S	●	●	08	08	100	8.2	10	DGN - 2	1515-M4x11	-	80-T15
ADKT-I-R/L-1010-2-R10-K-S	●	●	10	10	120	10.2	10				
ADKT-I-R/L-1212-2-R12-K-S	●	●	12	12	125	12.2	12	DGN - 3	2004-M8x1x20	-	AAL-05-4
ADKT-I-R/L-1616-3-R16-S	○	●	16	16	120	16.3	16				

ISCR Ucuna Uygundur. / Compatible with ISCR Insert.

➤ DIŞ ÇAP ALIN KANAL AÇMA TAKIMLARI
FACE EXTERNAL GROOVING TOOLHOLDERS

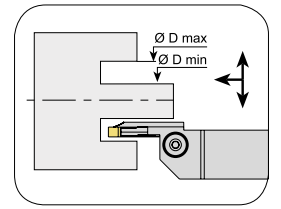
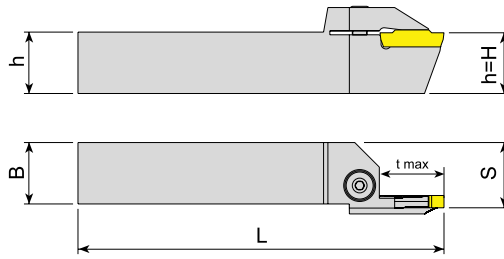

Takım Kodu Ordering Code	Stok Stock		Takım Ölçüleri (mm) Dimension (mm)							Kesici Uç Insert	Yedek Parçaları Spare Parts		
	R	L	h=H	B	L	S	t max	Ø D min	Ø D max		Sıkma Vidası Clamp Screw	Pul Stamp	Anahtar Allen Key
AAKT-KG-R/L-2525-44-70-4-T22	○	○	25	25	150	26.5	22	44	70	KG.. - 4	2004-M8x1x20	-	AAL-05-4
AAKT-KG-R/L-2525-60-120-4-T22	○	○	25	25	150	26.5	22	60	120				
AAKT-KG-R/L-2525-112-200-4-T22	○	○	25	25	150	26.5	22	112	200				

R: Sağ/Right L: Sol/Left ● Stokta/In Stock ○ Stokta Yok/Non Stock Item
KRLY Ucuna Uygundur. / Compatible with KRLY Insert.

Sipariş Örneği/Ordering Example : 1 ad./pcs. ADKT-I-R-0808-2-R10-S

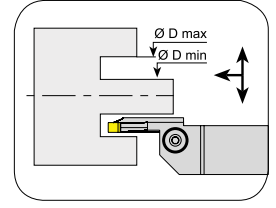
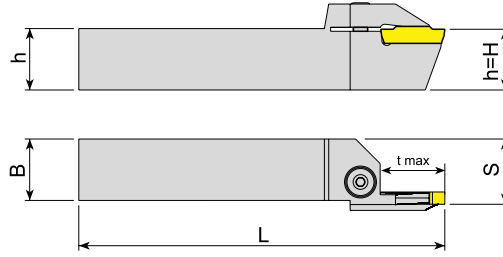

Takım Kodu Ordering Code	Stok Stock		Takım Ölçüleri (mm) Dimension (mm)							Kesici Uç Insert	Yedek Parçaları Spare Parts		
	R	L	h=H	B	L	S	t max	Ø D min	Ø D max		Sıkma Vidası Clamp Screw	Pul Stamp	Anahtar Allen Key
AAKT-K-R/L-2525-34-45-3-T17	●	●	25	25	150	26.5	17	34	45	MGM. - 3			
AAKT-K-R/L-2525-39-55-3-T17	●	●	25	25	150	26.5	17	39	55				
AAKT-K-R/L-2525-49-80-3-T17	●	●	25	25	150	26.5	17	49	80				
AAKT-K-R/L-2525-70-110-3-T17	●	●	25	25	150	26.5	17	70	110				
AAKT-K-R/L-2525-100-150-3-T17	●	●	25	25	150	26.5	17	100	150				
AAKT-K-R/L-2525-80-180-3-T32	●	●	25	25	150	26.5	32	80	180				
AAKT-K-R/L-2525-175-215-3-T22	●	●	25	25	150	26.5	22	175	215				
AAKT-K-R/L-2525-50-85-4-T22	●	●	25	25	150	26.5	22	50	85	MGM. - 4	2004-M8x1x20	-	AAL-05-4
AAKT-K-R/L-2525-70-110-4-T22	●	●	25	25	150	26.5	22	70	110				
AAKT-K-R/L-2525-100-150-4-T22	●	●	25	25	150	26.5	22	100	150				
AAKT-K-R/L-2525-80-180-4-T32	●	●	25	25	150	26.5	32	80	180				
AAKT-K-R/L-2525-180-800-4-T32	●	●	25	25	150	26.5	32	180	800				
AAKT-K-R/L-2525-70-110-5-T25	●	●	25	25	150	26.5	25	70	110	MGM. - 5			
AAKT-K-R/L-2525-100-150-5-T25	●	●	25	25	150	26.5	25	100	150				
AAKT-K-R/L-2525-80-180-5-T32	●	●	25	25	150	26.5	32	80	180				
AAKT-K-R/L-2525-140-200-5-T25	●	●	25	25	150	26.5	25	140	200				
AAKT-K-R/L-2525-180-800-5-T32	●	●	25	25	150	26.5	32	180	800				
AAKT-K-R/L-2525-60-100-6-T25	●	●	25	25	150	26.5	25	60	100	MGM. - 6			
AAKT-K-R/L-2525-60-100-6-T35	●	○	25	25	150	26.5	35	60	100				
AAKT-K-R/L-2525-100-200-6-T25	●	○	25	25	150	26.5	25	100	200				
AAKT-K-R/L-2525-100-200-6-T35	●	○	25	25	150	26.5	35	100	200				
AAKT-K-R/L-2525-140-300-6-T35	●	●	25	25	150	26.5	35	140	300	MGM. - 8			
AAKT-K-R/L-2525-140-300-8-T35	●	○	25	25	150	26.5	35	140	300				
AAKT-K-R/L-3232-140-350-8-T35	●	○	32	32	150	33.5	35	140	350				

R: Sağ/Right L: Sol/Left ● Stokta/In Stock ○ Stokta Yok/Non Stock Item
KRLY Ucuna Uygunudur. / Compatiple with KRLY Insert.

Sipariş Örneği/Ordering Example : 1 ad./pcs. AAKT-K-R-2525-34-45-3-T17

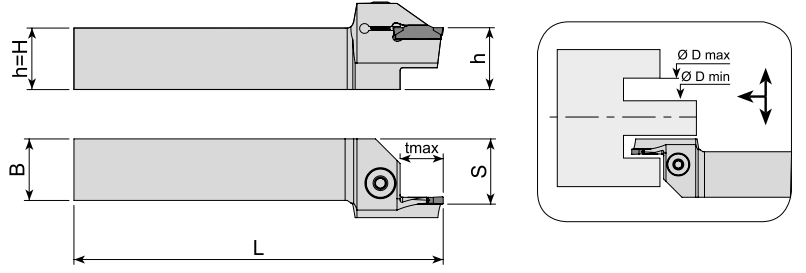

Takım Kodu Ordering Code	Stok Stock		Takım Ölçüleri (mm) Dimension (mm)							Kesici Uç Insert	Yedek Parçaları Spare Parts		
	R	L	h=H	B	L	S	t max	Ø D min	Ø D max		Sıkma Vidası Clamp Screw	Pul Stamp	Anahtar Allen Key
	●	○											
AAKT-ZCC2-R/L-2525-140-180-2-T4	●	○	25	25	150	26.5	4	140	180	Z.BD - 2	2004-M8x1x20	-	AAL-05-4
AAKT-ZCC2-R/L-2525-35-45-3-T17	●	●	25	25	150	26.5	17	35	45	Z.FD - 3			
AAKT-ZCC2-R/L-2525-39-55-3-T17	●	○	25	25	150	26.5	17	39	55				
AAKT-ZCC2-R/L-2525-49-80-3-T17	●	●	25	25	150	26.5	17	49	80				
AAKT-ZCC2-R/L-2525-70-110-3-T17	●	●	25	25	150	26.5	17	70	110				
AAKT-ZCC2-R/L-2525-100-150-3-T17	●	○	25	25	150	26.5	17	100	150	Z.GD - 4			
AAKT-ZCC2-R/L-2525-40-60-4-T22	●	○	25	25	150	26.5	22	40	60				
AAKT-ZCC2-R/L-2525-52-80-4-T22	●	●	25	25	150	26.5	22	52	80				
AAKT-ZCC2-R/L-2525-72-110-4-T22	●	●	25	25	150	26.5	22	72	110				
AAKT-ZCC2-R/L-2525-100-150-4-T22	●	●	25	25	150	26.5	22	100	150	Z.HD - 5			
AAKT-ZCC2-R/L-2525-140-200-4-T22	●	●	25	25	150	26.5	22	140	200				
AAKT-ZCC2-R/L-2525-55-95-5-T25	●	○	25	25	150	26.5	25	55	95				
AAKT-ZCC2-R/L-2525-85-140-5-T25	●	●	25	25	150	26.5	25	85	140				
AAKT-ZCC2-R/L-2525-130-200-5-T25	●	○	25	25	150	26.5	25	130	200	Z.KD - 6			
AAKT-ZCC2-R/L-2525-190-400-5-T25	●	●	25	25	150	26.5	25	190	400				
AAKT-ZCC2-R/L-2525-200-500-5-T17	●	●	25	25	150	26.5	25	200	500				
AAKT-ZCC2-R/L-2525-60-110-6-T15	●	○	25	25	150	26.5	15	60	110				

R: Sağ/Right L: Sol/Left ● Stokta/In Stock ○ Stokta Yok/Non Stock Item
ZCC Ucuna Uygunudur. / Compatible with ZCC Insert.

Sipariş Örneği/Ordering Example : 1 ad./pcs. AAKT-ZCC2-R-2525-140-180-2-T4



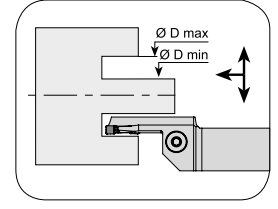
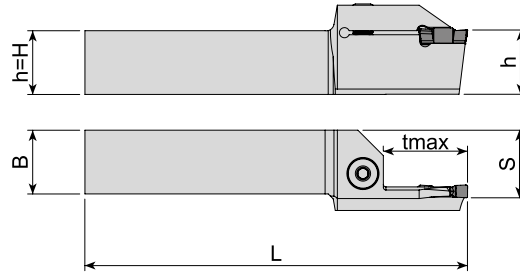

Takım Kodu Ordering Code	Stok Stock		Takım Ölçüleri (mm) Dimension (mm)							Kesici Uç Insert	Yedek Parçaları Spare Parts		
	R	L	h=H	B	L	S	t max	Ø D min	Ø D max		Sıkma Vidası Clamp Screw	Pul Stamp	Anahtar Allen Key
AAKT-IG-R/L-2525-40-60-4-T25	●	○	25	25	150	26.5	25	40	60	DGN / GRP - 4	2004-M8x1x20	-	AAL-05-4
AAKT-IG-R/L-2525-52-80-4-T25	●	●	25	25	150	26.5	25	52	80				
AAKT-IG-R/L-2525-70-110-4-T28	●	●	25	25	150	26.5	28	70	110				
AAKT-IG-R/L-2525-72-110-4-T25	○	○	25	25	150	26.5	25	72	110				
AAKT-IG-R/L-2525-100-150-4-T25	○	○	25	25	150	26.5	25	100	150				
AAKT-IG-R/L-2525-110-200-4-T28	●	○	25	25	150	26.5	28	110	200				
AAKT-IG-R/L-2525-110-200-4-T32	●	●	25	25	150	26.5	32	110	200				
AAKT-IG-R/L-2525-140-200-4-T25	○	○	25	25	150	26.5	25	140	200				
AAKT-IG-R/L-2525-180-800-4-T28	●	●	25	25	150	26.5	28	180	800				
AAKT-IG-R/L-2525-200-800-4-T25	○	○	25	25	150	26.5	25	200	800				
AAKT-IG-R/L-2525-70-110-5-T32	●	○	25	25	150	26.5	32	70	110	DGN / GRP - 5			
AAKT-IG-R/L-2525-110-200-5-T32	●	●	25	25	150	26.5	32	110	200				
AAKT-IG-R/L-2525-180-800-5-T32	●	●	25	25	150	26.5	32	180	800				
AAKT-IG-R/L-2525-58-100-6-T32	●	○	25	25	150	26.5	32	58	100	DGN / GRP - 6			
AAKT-IG-R/L-2525-88-180-6-T32	●	○	25	25	150	26.5	32	88	180				

R: Sağ/Right L: Sol/Left ● Stokta/In Stock ○ Stokta Yok/Non Stock Item
ISCR Ucuna Uygundur. / Compatiple with ISCR Insert.

Sipariş Örneği/Ordering Example : 1 ad./pcs. AAKT-IG-R-2525-40-60-4-T25



➤ L TİP ALIN KANAL AÇMA TAKIMLARI
L TYPE FACE EXTERNAL GROOVING TOOLHOLDERS

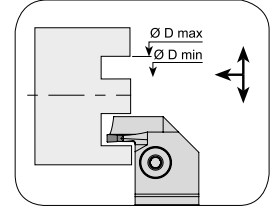
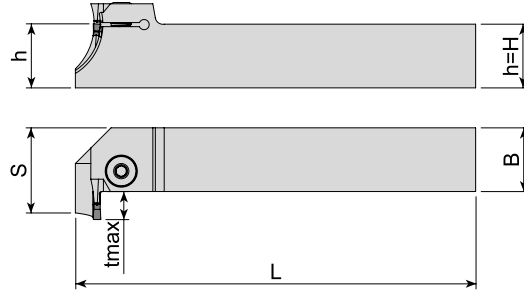

Takım Kodu Ordering Code	Stok Stock		Takım Ölçüleri (mm) Dimension (mm)							Kesici Uç Insert	Yedek Parçaları Spare Parts		
	R	L	h=H	B	L	S	t max	Ø D min	Ø D max		Sıkma Vidası Clamp Screw	Pul Stamp	Anahtar Allen Key
ALKT-ZCC2-R/L-2525-35-45-3-T10	●	○	25	25	150	36	10	35	45	Z.FD - 3	2004-M8x1x20	-	AAL-05-4
ALKT-ZCC2-R/L-2525-39-55-3-T10	●	○	25	25	150	36	10	39	55				
ALKT-ZCC2-R/L-2525-35-∞-3-T4	●	●	25	25	150	30	4	35	∞	Z.GD - 4	2004-M8x1x20	-	AAL-05-4
ALKT-ZCC2-R/L-2525-40-60-4-T14	●	○	25	25	150	40	14	40	60				
ALKT-ZCC2-R/L-2525-52-80-4-T14	●	○	25	25	150	40	14	52	80	Z.GD - 4	2004-M8x1x20	-	AAL-05-4
ALKT-ZCC2-R/L-2525-72-110-4-T14	●	○	25	25	150	40	14	72	110				
ALKT-ZCC2-R/L-2525-100-230-4-T14	●	○	25	25	150	40	14	100	230	Z.GD - 4	2004-M8x1x20	-	AAL-05-4
ALKT-ZCC2-R/L-2525-40-∞-4-T4	●	○	25	25	150	30	4	40	∞				

ZCC Ucuna Uygundur. / Compatible with ZCC Insert.

➤ KESME VE DERİN KANAL AÇMA LAMALARI
BLADES FOR PARTING AND DEEP GROOVING

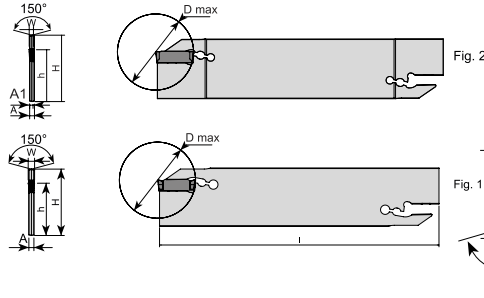

Takım Kodu Ordering Code	Stok Stock		Takım Ölçüleri (mm) Dimension (mm)							Kesici Uç Insert	Yedek Parçaları Spare Parts	
	B	W	A	A1	l	h	D max	Fig.	Anahtar Key			
AKL-I-26-2	●	○	26	1.9-2.5	1.6	-	110	21.4	39	1	DGN - 2	ALA-01
AKL-I-32-2	●	○	32	1.9-2.5	2.4	1.8	150	25	39	2		
AKL-I-26-3	●	○	26	3-3.18	2.4	-	110	21.4	39	1	DGN - 3	ALA-01
AKL-I-32-3	●	○	32	3-3.18	2.4	-	150	25	39	1		
AKL-I-26-4	●	○	26	4	3.2	-	110	21.4	80	1	DGN / GRP - 4	ALA-01
AKL-I-32-4	●	○	32	4	3.2	-	150	25	100	1		

R: Sağ/Right L: Sol/Left ● Stokta/In Stock ○ Stokta Yok/Non Stock Item
ISCR Ucuna Uygundur. / Compatible with ISCR Insert.

Sipariş Örneği/Ordering Example : 1 ad./pcs. ALKT-ZCC2-R-2525-35-45-3-T10



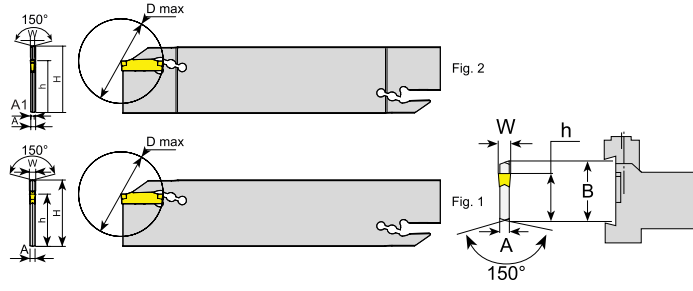

Takım Kodu Ordering Code	Stok Stock	Takım Ölçüleri (mm) Dimension (mm)								Kesici Uç Insert	Yedek Parçaları Spare Parts	
		B	W	A	A1	l	h	D max	Fig.		Anahtar Key	
AKL-123-32-3	●	32	3	2.4	-	150	25	39	1		ALA-01	
AKL-123-32-4	●	32	4	3.2	-	150	25	39	1			

SNDVK Ucuna Uygunudur. / Compatible with SNDVK Insert.

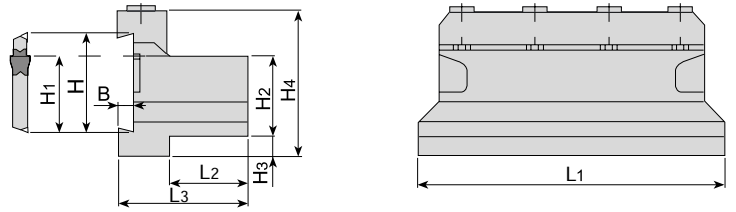

Takım Kodu Ordering Code	Stok Stock	Takım Ölçüleri (mm) Dimension (mm)									Yedek Parçaları Spare Parts		
		H	H1	H2	H3	H4	B	L1	L2	L3	Pabuç Clamp	Pabuç Vidası Clamp Screw	Anahtar Allen Key
ALBU-20-26	●	26	21.4	20	8	38	4	87	19	33		2505-M6x25	AAL-07-5
ALBU-25-26	●	26	21.4	25	3	38	4	110	20	34			
ALBU-20-32	●	32	25	20	13	48	5.5	100	19	35		2505-M6x30	AAL-07-5
ALBU-25-32	●	32	25	25	8	48	5.5	110	20	36			
ALBU-32-32	●	32	25	32	3	48	5.5	120	28	44			

R: Sağ/Right L: Sol/Left ● Stokta/In Stock ○ Stokta Yok/Non Stock Item

Sipariş Örneği/Ordering Example : 1 ad./pcs. AKL-123-32-3

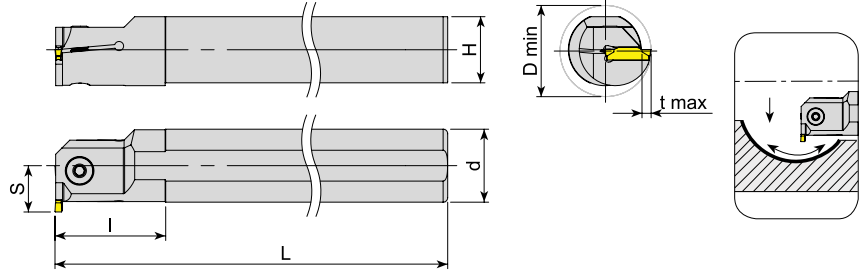

Takım Kodu Ordering Code	Stok Stock		Takım Ölçüleri (mm) Dimension (mm)							Kesici Uç Insert	Yedek Parçaları Spare Parts	
	R	L	d	D min	L	l	t max	H	S		Sıkma Vidası Clamp Screw	Anahtar Allen Key
AIKT-K-R/L-16-2-T4	●	●	16	21	150	28	4	14.8	12	MGM. - 2	2503-M4x10	AAL-03-3
AIKT-K-R/L-20-2-T4	●	●	20	25	170	30	4	18.3	14		2503-M4x12	
AIKT-K-R/L-25-2-T6	●	●	25	32	200	40	6	23	18.5		2504-M5x12	
AIKT-K-R/L-20-3-T6	●	●	20	27	170	30	6	18.3	16	MGM. - 3	2504-M5x12	AAL-05-4
AIKT-K-R/L-20-3-T7	●	●	20	25	170	38	7	18.3	13		2504-M5x12	
AIKT-K-R/L-25-3-T6	●	●	25	32	200	40	6	23	18.5		2504-M5x16	
AIKT-K-R/L-25-3-T10	●	●	25	32	200	48	10	23	17		2004-M8x1x20	
AIKT-K-R/L-32-3-T6	●	●	32	39	250	50	6	30	22		2504-M5x12	
AIKT-K-R/L-32-3-T12	●	●	32	39	250	53	12	30	22		2504-M5x16	
AIKT-K-R/L-40-3-T6	●	●	40	47	300	55	6	37.5	26		2004-M8x1x20	
AIKT-K-R/L-40-3-T12	●	○	40	48	300	63	12	37.5	27		2504-M5x12	
AIKT-K-R/L-20-4-T6	●	●	20	27	170	30	6	18.3	16		MGM. - 4	
AIKT-K-R/L-20-4-T7	●	○	20	25	170	38	7	18.3	13	2504-M5x16		
AIKT-K-R/L-25-4-T6	●	●	25	32	200	40	6	23	18.5	2504-M5x16		
AIKT-K-R/L-25-4-T10	●	●	25	32	200	49	10	23	17	2004-M8x1x20		
AIKT-K-R/L-32-4-T6	●	●	32	39	250	50	6	30	22	2504-M5x12		
AIKT-K-R/L-32-4-T12	●	●	32	39	250	53	12	30	22	2504-M5x16		
AIKT-K-R/L-40-4-T6	●	●	40	47	300	55	6	37.5	26	2004-M8x1x20		
AIKT-K-R/L-40-4-T12	●	●	40	48	300	63	12	37.5	27	2504-M5x16		
AIKT-K-R/L-25-5-T7	●	●	25	33	200	40	7	23	19.5	MGM. - 5		2504-M5x16
AIKT-K-R/L-32-5-T7	●	●	32	40	250	50	7	30	23		2004-M8x1x20	
AIKT-K-R/L-40-5-T7	●	●	40	48	300	55	7	37.5	27		2004-M8x1x20	

R: Sağ/Right L: Sol/Left ● Stokta/In Stock ○ Stokta Yok/Non Stock Item
KRLY Ucuna Uygunudur. / Compatiple with KRLY Insert.

Sipariş Örneği/Ordering Example : 1 ad./pcs. AIKT-K-R-16-2-T4

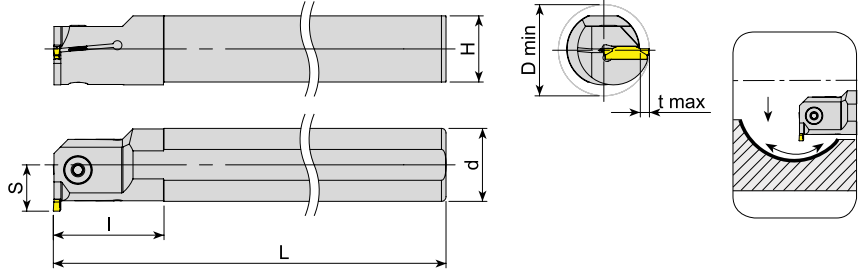

Takım Kodu Ordering Code	Stok Stock		Takım Ölçüleri (mm) Dimension (mm)						Kesici Uç Insert	Yedek Parçaları Spare Parts		
	R	L	d	D min	L	l	t max	H		S	Sıkma Vidası Clamp Screw	Anahtar Allen Key
AIKT-KG-R/L-25-2-T7	●	●	25	33	200	40	7	23	19.5	KG.. - 2	2504-M5x12	AAL-05-4
AIKT-KG-R/L-25-3-T7	○	○	25	33	200	40	7	23	19.5	KG.. - 3	2504-M5x16	
AIKT-KG-R/L-40-3-T8	●	○	40	50	300	55	8	37.5	28	KG.. - 3	2504-M5x16	
AIKT-KG-R/L-25-4-T8	●	●	25	34	200	40	8	23	20.5	KG.. - 4	2504-M5x16	

KRLY Ucuna Uygun. / Compatible with KRLY Insert.

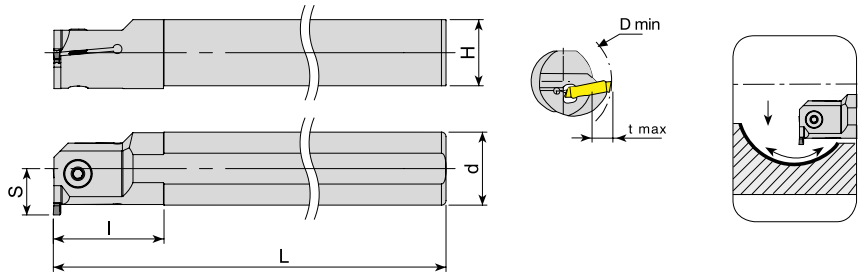

Takım Kodu Ordering Code	Stok Stock		Takım Ölçüleri (mm) Dimension (mm)						Kesici Uç Insert	Yedek Parçaları Spare Parts		
	R	L	d	D min	L	l	t max	H		S	Sıkma Vidası Clamp Screw	Anahtar Allen Key
AIKT-H-R/L-25-3-T8	●	●	25	34	200	40	8	23	20.5	S229 - 3	2504-M5x16	AAL-05-4
AIKT-H-R/L-32-3-T7	●	●	32	40	250	50	7	30	23		2004-M8x1x20	
AIKT-H-R/L-40-3-T7	●	●	40	48	300	55	7	37.5	27		2004-M8x1x20	
AIKT-H-R/L-25-4-T8	●	●	25	34	200	40	8	23	20.5	S229 - 4	2504-M5x16	
AIKT-H-R/L-32-4-T7	●	●	32	40	250	50	7	30	23		2004-M8x1x20	
AIKT-H-R/L-40-4-T7	●	○	40	48	300	55	7	37.5	27	S229 - 5	2504-M5x16	
AIKT-H-R/L-25-5-T8	●	●	25	34	200	40	8	23	20.5		2504-M5x16	
AIKT-H-R/L-32-5-T7	●	○	32	40	250	50	7	30	23		2004-M8x1x20	
AIKT-H-R/L-40-5-T7	●	○	40	48	300	55	7	37.5	27	2004-M8x1x20		

R: Sağ/Right L: Sol/Left ● Stokta/In Stock ○ Stokta Yok/Non Stock Item
HRN Ucuna Uygun. / Compatible with HRN Insert.

Sipariş Örneği/Ordering Example : 1 ad./pcs. AIKT-KG-R-25-2-T7

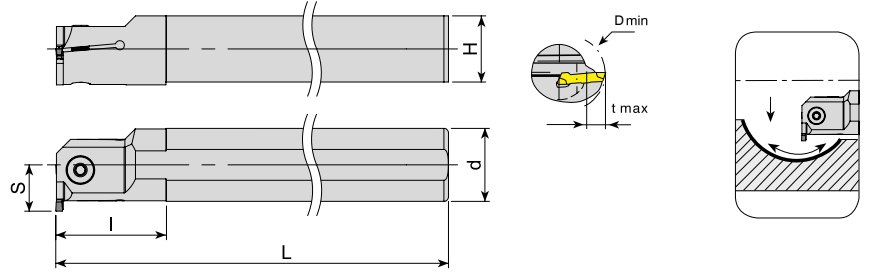

Takım Kodu Ordering Code	Stok Stock		Takım Ölçüleri (mm) Dimension (mm)							Kesici Uç Insert	Yedek Parçaları Spare Parts	
	R	L	d	D min	L	l	t max	H	S		Sıkma Vidası Clamp Screw	Anahtar Allen Key
AIKT-HK-R/L-20-2-T6	●	○	20	26	170	30	6	18.3	16	S224 - 2	2503-M4x12	AAL-03-3
AIKT-HK-R/L-25-2-T6	●	○	25	32	200	40	6	23	18.5		2504-M5x16	AAL-05-4
AIKT-HK-R/L-20-3-T6	●	○	20	27	170	30	6	18.3	16	S224 - 3	2504-M5x12	
AIKT-HK-R/L-25-3-T6	●	○	25	32	200	40	6	23	18.5		2504-M5x16	
AIKT-HK-R/L-32-3-T6	●	○	32	39	250	50	6	30	22	S224 - 4	2004-M8x1x20	AAL-05-4
AIKT-HK-R/L-20-4-T6	●	○	20	27	170	30	6	18.3	16		2504-M5x12	
AIKT-HK-R/L-25-4-T6	●	○	25	32	200	40	6	23	18.5	S224 - 4	2504-M5x16	AAL-05-4
AIKT-HK-R/L-32-4-T6	●	○	32	39	250	50	6	30	22		2004-M8x1x20	
AIKT-HS223-R/L-20-2-T5	●	○	20	26	170	33	5	18.3	15	S223 - 2	2503-M4x12	AAL-03-3
AIKT-HS223-R/L-25-2-T5	●	○	25	31	200	40	5	23	17.5		2504-M5x16	AAL-05-4
AIKT-HS223-R/L-20-3-T6	●	○	20	27	170	33	6	18.3	16	S223 - 3	2504-M5x12	
AIKT-HS223-R/L-25-3-T6	●	○	25	32	200	40	6	23	18.5		2504-M5x16	

HRN Ucuna Uygun. / Compatible with HRN Insert.

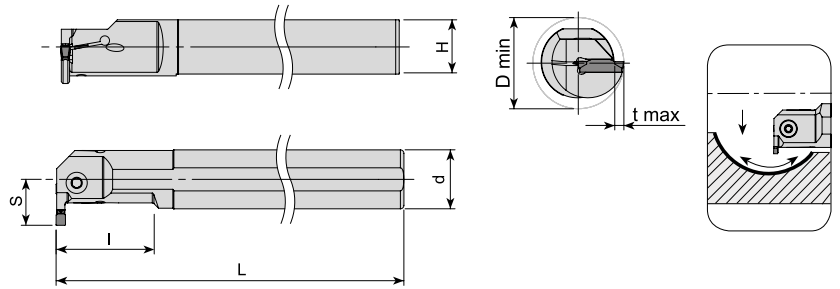

Takım Kodu Ordering Code	Stok Stock		Takım Ölçüleri (mm) Dimension (mm)							Kesici Uç Insert	Yedek Parçaları Spare Parts	
	R	L	d	D min	L	l	t max	H	S		Sıkma Vidası Clamp Screw	Anahtar Allen Key
AIKT-KM-R/L-20-2-T7	●	○	20	25	170	40	7	18.3	13	A4. - 2	2503-M4x12	AAL-03-3
AIKT-KM-R/L-20-3-T7	●	○	20	25	170	40	7	18.3	13		2504-M5x12	AAL-05-4
AIKT-KM-R/L-25-3-T10	●	○	25	32	200	50	10	23	17	A4. - 3	2505-M6x16	AAL-07-5
AIKT-KM-R/L-32-3-T12	●	○	32	40	250	64	12	30	22		2505-M6x20	
AIKT-KM-R/L-40-3-T12	●	○	40	48	300	80	12	37.5	27	A4. - 4	2504-M5x12	AAL-05-4
AIKT-KM-R/L-20-4-T7	●	○	20	25	170	40	7	18.3	13			

R: Sağ/Right L: Sol/Left ● Stokta/In Stock ○ Stokta Yok/Non Stock Item KNMTL Ucuna Uygun. / Compatible with KNMTL Insert.

Sipariş Örneği/Ordering Example : 1 ad./pcs. AIKT-HK-R-20-2-T6

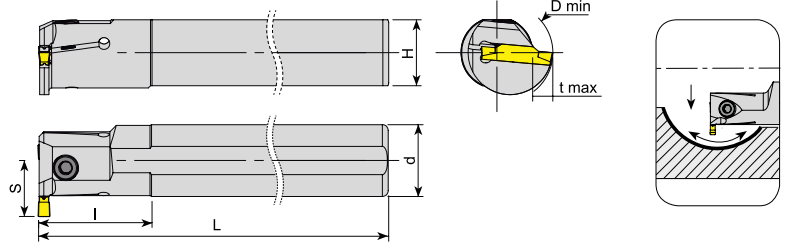

Takım Kodu Ordering Code	Stok Stock		Takım Ölçüleri (mm) Dimension (mm)							Kesici Uç Insert	Yedek Parçaları Spare Parts		
	R	L	d	D min	L	l	t max	H	S		Sıkma Vidası Clamp Screw	Anahtar Allen Key	
AIKT-123-R/L-32-2-T7	●	○	32	41	250	45	7	30	23	123 - 2	2004-M8x1x20	AAL-05-4	
AIKT-123-R/L-20-3-T6	●	○	20	32	170	30	6	18.3	16				123 - 3
AIKT-123-R/L-25-3-T7	●	○	25	32	200	40	7	23	19.5	123 - 4	2004-M8x1x20		
AIKT-123-R/L-32-3-T9	●	○	32	41	250	50	9	30	25		123 - 5		2504-M5x16
AIKT-123-R/L-20-4-T8	●	○	20	29	170	30	8	18.3	18	123 - 5			2004-M8x1x20
AIKT-123-R/L-25-4-T7	●	○	25	32	200	40	7	23	19.5		123 - 5		2504-M5x16
AIKT-123-R/L-32-4-T7	●	○	32	41	250	45	7	30	23	123 - 5			2004-M8x1x20
AIKT-123-R/L-32-4-T10	●	○	32	43	250	50	10	30	26		123 - 5		2504-M5x16
AIKT-123-R/L-25-5-T8	●	○	25	34	200	40	8	23	20.5	123 - 5			2004-M8x1x20
AIKT-123-R/L-32-5-T11	●	○	32	43	250	50	11	30	27				

SNDVK Ucuna Uygundur. / Compatible with SNDVK Insert.

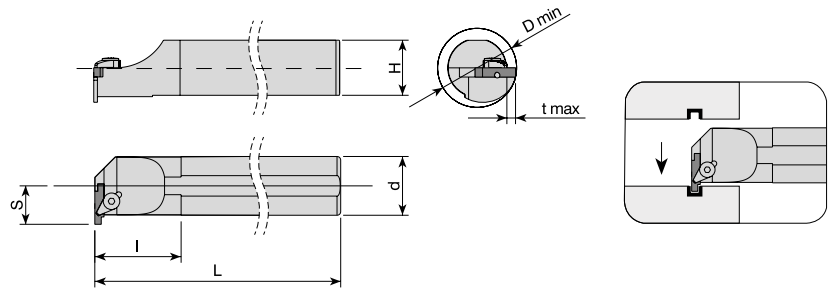

Takım Kodu Ordering Code	Stok Stock		Takım Ölçüleri (mm) Dimension (mm)							Kesici Uç Insert	Yedek Parçaları Spare Parts			
	R	L	d	D min	L	l	t max	H	S		Baskı Parçası Wedge Clamp	Sıkma Vidası Clamp Screw	Pim Pin	Anahtar Allen Key
AIKT-154.91-R/L-16-3-T3	●	●	16	20	150	35	3	14.8	11	154.91 - 3	ACK-06	AKV-10-M6x14	APM-06	AAL-05-4
AIKT-154.91-R/L-20-3-T4	●	●	20	25	170	38	4	18.3	14					
AIKT-154.91-R/L-25-3-T4	●	●	25	31	200	40	4	23	16.5	154.91 - 5	ACK-03	AKV-07-M6x22	AAL-03-3	
AIKT-154.91-R/L-25-5-T5	●	●	25	31	200	45	5	23	17.5					
AIKT-154.91-R/L-32-5-T5	●	●	32	38	250	50	5	30	21					

R: Sağ/Right L: Sol/Left ● Stokta/In Stock ○ Stokta Yok/Non Stock Item
SNDVK Ucuna Uygundur. / Compatible with SNDVK Insert.

Sipariş Örneği/Ordering Example : 1 ad./pcs. AIKT-123-R-32-2-T7

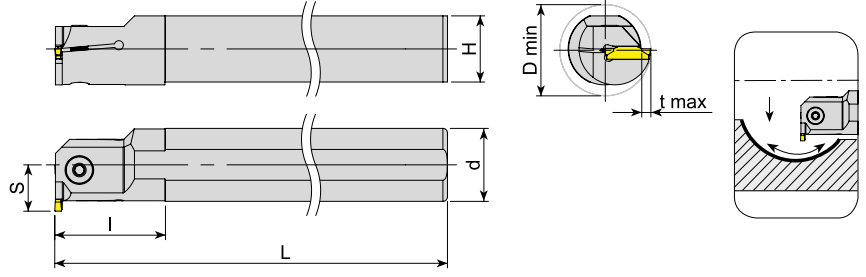

Takım Kodu Ordering Code	Stok Stock		Takım Ölçüleri (mm) Dimension (mm)							Kesici Uç Insert	Yedek Parçaları Spare Parts	
	R	L	d	D min	L	l	t max	H	S		Sıkma Vidası Clamp Screw	Anahtar Allen Key
AIKT-ZCC2-R/L-16-2-T4	●	○	16	21	150	28	4	14.8	12	Z.BD - 2	2503-M4x10	AAL-03-3
AIKT-ZCC2-R/L-20-3-T5	●	●	20	27	170	30	5	18.3	15		Z.FD - 3	
AIKT-ZCC2-R/L-25-3-T5	●	○	25	31	200	40	5	23	17.5	2504-M5x16		
AIKT-ZCC2-R/L-32-3-T6	●	○	32	39	250	50	6	30	22	2004-M8x1x20		
AIKT-ZCC2-R/L-32-3-T8	●	○	32	41	250	50	8	30	24	Z.GD - 4	2504-M5x16	AAL-05-4
AIKT-ZCC2-R/L-25-4-T6	●	○	25	32	200	40	6	23	18.5			
AIKT-ZCC2-R/L-32-4-T7	●	○	32	40	250	50	7	30	23	Z.HD - 5	2004-M8x1x20	
AIKT-ZCC2-R/L-32-4-T8	●	○	32	41	250	50	8	30	24			
AIKT-ZCC2-R/L-32-4-T10	●	○	32	43	250	50	10	30	26			
AIKT-ZCC2-R/L-32-5-T7	●	○	32	40	250	50	7	30	23	Z.HD - 5	2004-M8x1x20	
AIKT-ZCC2-R/L-32-5-T8	●	○	32	41	250	50	8	30	24			
AIKT-ZCC2-R/L-40-5-T8	●	○	40	49	300	55	8	37.5	28			
AIKT-ZCC2-R/L-40-5-T10	●	○	40	51	300	55	10	37.5	30			

ZCC Ucuna Uygundur. / Compatible with ZCC Insert.

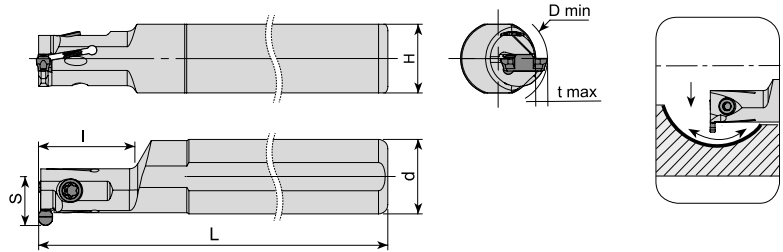

Takım Kodu Ordering Code	Stok Stock		Takım Ölçüleri (mm) Dimension (mm)							Kesici Uç Insert	Yedek Parçaları Spare Parts	
	R	L	d	D min	L	l	t max	H	S		Sıkma Vidası Clamp Screw	Anahtar Allen Key
AIKT-IGE-R/L-16-2-T2.5-H	●	○	16	13	125	20	2.5	14.8	10.5	GEPI - 2	1315-M4x11	80-T15
AIKT-IGE-R/L-16-3-T2.5-H	●	○	16	13	125	20	2.5	14.8	10.5			

R: Sağ/Right L: Sol/Left ● Stokta/In Stock ○ Stokta Yok/Non Stock Item
ISCR Ucuna Uygundur. / Compatible with ISCR Insert.

Sipariş Örneği/Ordering Example : 1 ad./pcs. AIKT-ZCC-R-20-3-T5

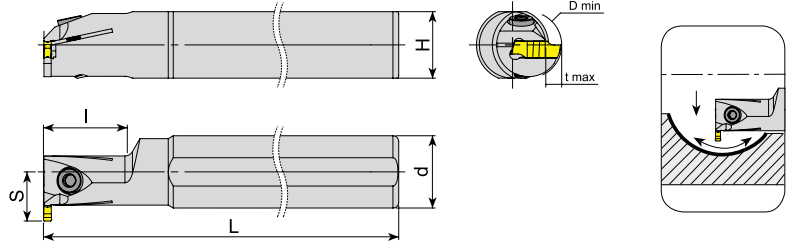

Takım Kodu Ordering Code	Stok Stock		Takım Ölçüleri (mm) Dimension (mm)							Kesici Uç Insert	Yedek Parçaları Spare Parts	
	R	L	d	D min	L	l	t max	H	S		Sıkma Vidası Clamp Screw	Anahtar Key
AIKT-IGI-R/L-20-3-T4	●	●	20	20	170	25	4	18.3	14.5	GIMIY / GIPI - 3	1020-M5x14	80-T20
AIKT-IGI-R/L-25-3-T5	●	●	25	23	200	30	5	23	17		2504-M5x16	AAL-05-4
AIKT-IGI-R/L-32-3-T5	●	●	32	31	250	30	5	30	21	GIMIY / GIPI - 4	2004-M8x1x20	80-T20
AIKT-IGI-R/L-20-4-T4	●	●	20	20	170	25	4	18.3	14.5		1020-M5x14	80-T20

ISCR Ucuna Uygunudur. / Compatiple with ISCR Insert.

Not: "l" boyları D min çapa göre verilmiştir.
Note: Lengths of "l" are given according to D min diameter.

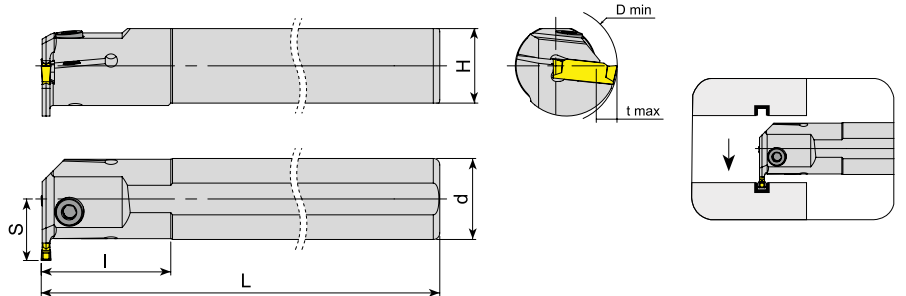

Takım Kodu Ordering Code	Stok Stock		Takım Ölçüleri (mm) Dimension (mm)							Kesici Uç Insert	Yedek Parçaları Spare Parts	
	R	L	d	D min	L	l	t max	H	S		Sıkma Vidası Clamp Screw	Anahtar Allen Key
AIKT-I-R/L-20-3-T5	●	○	20	26	170	25	5	18.3	15.5	DGN - 3	2504-M5x12	AAL-05-4
AIKT-I-R/L-25-3-T6	●	○	25	32	200	40	6	23	19		2504-M5x16	

R: Sağ/Right L: Sol/Left ● Stokta/In Stock ○ Stokta Yok/Non Stock Item
ISCR Ucuna Uygunudur. / Compatiple with ISCR Insert.

Sipariş Örneği/Ordering Example : 1 ad./pcs. AIKT-IGI-R-20-3-T4

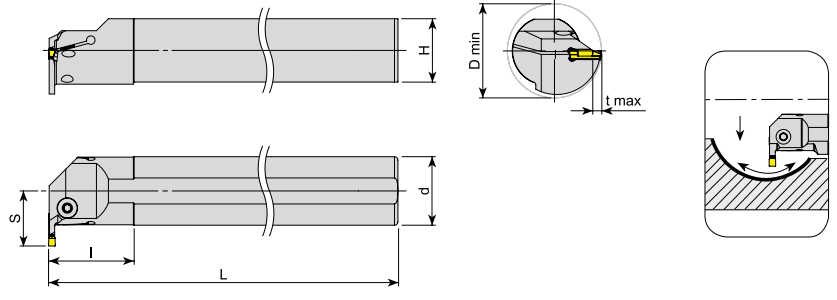

Takım Kodu Ordering Code	Stok Stock		Takım Ölçüleri (mm) Dimension (mm)							Kesici Uç Insert	Yedek Parçaları Spare Parts	
	R	L	d	D min	L	l	t max	H	S		Sıkma Vidası Clamp Screw	Anahtar Allen Key
AIKT-IG-R/L-25-4-T10-H	●	●	25	36	200	40	10	23	22.7	DGN / GRP - 4	2504-M5X16	AAL-05-4
AIKT-IG-R/L-32-4-T10-H	●	●	32	43	250	45	10	30	26.2		2004-M8x1x20	
AIKT-IG-R/L-40-4-T12-H	●	●	40	53	300	50	12	37.5	32.2		2504-M5X16	
AIKT-IG-R/L-25-5-T10-H	●	○	25	36	200	40	10	23	22.7	DGN / GRP - 5	2504-M5X16	
AIKT-IG-R/L-32-5-T10-H	●	○	32	43	250	45	10	30	26.2		2004-M8x1x20	
AIKT-IG-R/L-40-5-T12-H	●	○	40	53	300	50	12	37.5	32.2			
AIKT-IG-R/L-50-5-T12-H	●	○	50	63	350	60	12	47	37.2			

ISCR Ucuna Uygunudur. / Compatible with ISCR Insert.

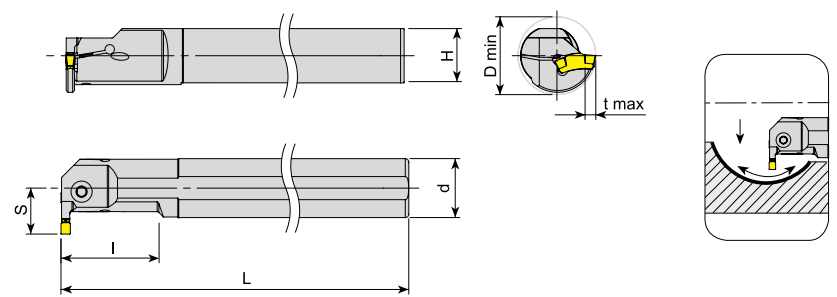

Takım Kodu Ordering Code	Stok Stock		Takım Ölçüleri (mm) Dimension (mm)							Kesici Uç Insert	Yedek Parçaları Spare Parts	
	R	L	d	D min	L	l	t max	H	S		Sıkma Vidası Clamp Screw	Anahtar Key
AIKT-ITG-R/L-16-3-T6-H	●	●	16	20	150	25	6	14.8	12	TGM. - 3	1020-M4.5X14	80-T20
AIKT-ITG-R/L-20-3-T6-H	●	●	20	25	170	32	6	18.3	14.2		1020-M4.5X16	
AIKT-ITG-R/L-25-3-T8-H	●	●	25	32	200	40	8	23	18.8		2504-M5X16	AAL-05-4
AIKT-ITG-R/L-32-3-T8-H	●	●	32	38	250	49	8	30	22	2004-M8x1x20		
AIKT-ITG-R/L-20-4-T6-H	●	●	20	25	170	33	6	18.3	14.2	TGM. - 4	1020-M4.5X16	80-T20
AIKT-ITG-R/L-25-4-T7-H	●	●	25	31	200	41	7	23	17.5		2504-M5X16	AAL-05-4
AIKT-ITG-R/L-25-4-T9-H	●	●	25	32.5	200	41	9	23	19.5			
AIKT-ITG-R/L-32-4-T11-H	●	●	32	42	250	50	11	30	25.5			
AIKT-ITG-R/L-40-4-T11-H	●	●	40	53	300	50	11	37.5	32		2004-M8x1x20	

R: Sağ/Right L: Sol/Left ● Stokta/In Stock ○ Stokta Yok/Non Stock Item
ISCR Ucuna Uygunudur. / Compatible with ISCR Insert.

Sipariş Örneği/Ordering Example : 1 ad./pcs. AIKT-IG-R-25-4-T10-H

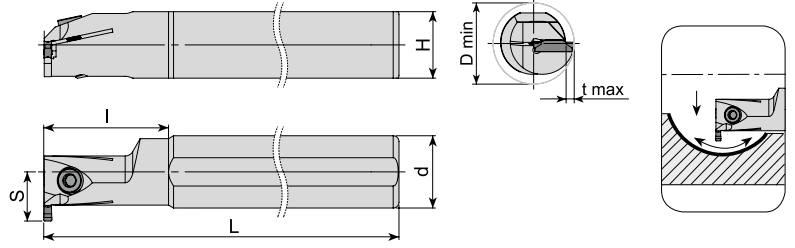

Takım Kodu Ordering Code	Stok Stock		Takım Ölçüleri (mm) Dimension (mm)							Kesici Uç Insert	Yedek Parçaları Spare Parts	
	R	L	d	D min	L	I	t max	H	S		Sıkma Vidası Clamp Screw	Anahtar Allen Key
AIKT-GP-R/L-20-2-T4	●	○	20	25	170	30	4	18.3	14.5	GP - 2	2503-M4x12	AAL-03-3
AIKT-GP-R/L-20-3-T6	●	○	20	27	170	30	6	18.3	16			
AIKT-GP-R/L-25-3-T6	●	○	25	32	200	40	6	23	18.5	GP - 3	2504-M5x16	AAL-05-4
AIKT-GP-R/L-32-3-T6	●	○	32	39	250	50	6	30	22			
AIKT-GP-R/L-20-4-T6	●	○	20	27	170	30	6	18.3	16	GP - 4	2504-M5x16	AAL-05-4
AIKT-GP-R/L-25-4-T6	●	○	25	32	200	40	6	23	18.5			
AIKT-GP-R/L-32-4-T6	●	○	32	39	250	50	6	30	22			

PLBT Ucuna Uygundur. / Compatiple with PLBT Insert.

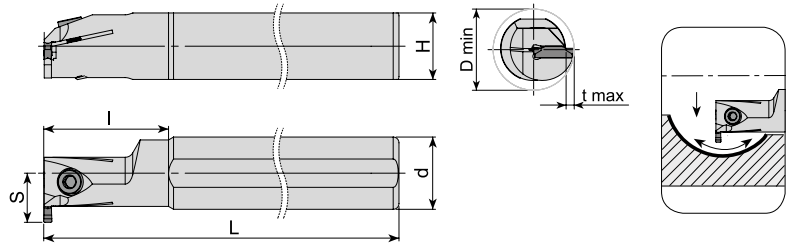

Takım Kodu Ordering Code	Stok Stock		Takım Ölçüleri (mm) Dimension (mm)							Kesici Uç Insert	Yedek Parçaları Spare Parts	
	R	L	d	D min	L	I	t max	H	S		Sıkma Vidası Clamp Screw	Anahtar Allen Key
AIKT-SGC-R-25-3-T6	●	○	25	32	200	40	6	23	18.5	GCM N30	2504-M5x16	AAL-05-4
AIKT-SGC-R-32-3-T6	●	○	32	39	250	50	6	30	22			
AIKT-SGC-R-40-3-T6	●	○	40	47	300	55	6	37.5	26			

R: Sağ/Right L: Sol/Left ● Stokta/In Stock ○ Stokta Yok/Non Stock Item
SMTM Ucuna Uygundur. / Compatiple with SMTM Insert.

Sipariş Örneği/Ordering Example : 1 ad./pcs. AIKT-GP-R-20-2-T4

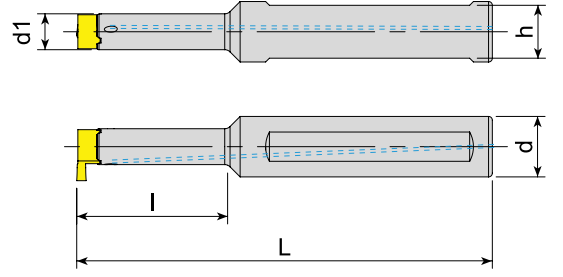

Takım Kodu Ordering Code	Stok Stock	Takım Ölçüleri (mm) Dimension (mm)					Kesici Uç Insert	Yedek Parçaları Spare Parts	
		d	d1	L	l	h		Sıkma Vidası Clamp Screw	Tork Anahtar Torx Key
AIKT-MB07-A16-090-15	●	16	7.4	90	15	14	MB - 07	4008-M3x8	80-T08
AIKT-MB07-A16-090-22	●	16	7.4	90	22	14			
AIKT-MB09-A16-090-19	●	16	9.5	90	19	14	MB - 09	1515-M4x11	80-T15
AIKT-MB09-A16-095-28	●	16	9.5	95	28	14			
AIKT-MB09-A16-110-40	●	16	9.5	110	40	14			

R: Sağ/Right L: Sol/Left ● Stokta/In Stock ○ Stokta Yok/Non Stock Item
SNDVK Ucuna Uygunudur. / Compatible with SNDVK Insert.

Sipariş Örneği/Ordering Example : 1 ad./pcs. AIKT-MB07-A16-090-15

